

COURSE UNIT

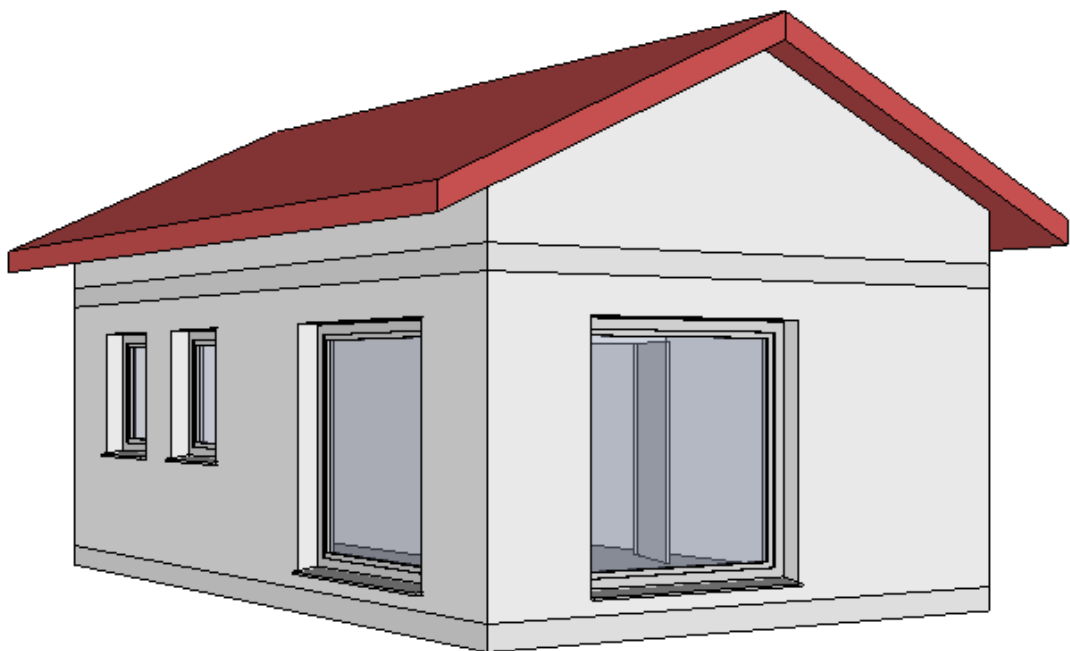

Quantities

TABLE OF CONTENTS

COURSE UNIT	1
TABLE OF CONTENTS	2
1. Course unit - Evaluation	3
2. Evaluation database	17
3. Areas and standards	18
4. Room finishes	48
5. Construction parts.....	67
6. Adding additional properties.....	111
7. Defining 3D objects as a construction part.....	113
8. Control functions	127
9. Evaluation.....	9-135
10. Evaluation options and lists	138
11. Examples	166

1. Course unit - Evaluation

Recommendation

To learn how Evaluation functions, it is recommended that you first study Chapters 1.1 to 1.5.

EliteCAD Version

Minimum requirement for this course unit:

EliteCAD ARCHITECTURE Version 13.

The version can be checked using the “?” > Info menu.

This menu can also be used to load an internet update.

Project for evaluation

When EliteCAD AR13 is installed, sample projects are imported.

The sample project for evaluation is called

CAD_Object_Evaluation.

1.1 Innovations for EliteCAD AR13

- Multi-layer floors (slabs), roofs and floorings
- Four layers:
 - Load-bearing
 - Non load-bearing
 - Subconstruction
 - Facing
- Automatic layer type management using synonyms
- New height definition functionality for calculations of living space
- System-built wall (all layers evaluated together)
- Hierarchical structuring type in quantities manager. Living space allocated to room.
- Property “Description” and in later updates “Type”
- Evaluation lists structured by layer types and system-built walls
- Living space verification in graph format and as a list
- New lists for the following construction parts:
 - Suspended ceilings (hollow ceiling)
 - Banisters
 - Internal and external windowsills
(Switzerland: window ledges and windowsills)
 - Free objects
- Available in later updates:
 - ÖNORM B 1800 issued 2011
 - EN 15221-6 Area and space measurement in Facility Management
 - Verification of gross floor area (Brutto-Raumhalt, BRI) or building volume (Gebäudevolumen, GV)

1.2 Evaluation - method of function

Overview

Construction parts, rooms and floors are objects. These are broken down for evaluation into object types (e.g. floor data). For the object types, the various properties are evaluated. Construction part layers are divided up into layer types (e.g. facing). These are evaluated as object types (e.g. wall facing).

The layer type is set by the choice of material, automatically or manually.

For walls, the choice of materials automatically determines the trades. For wall openings, a deduction audit is carried out in accordance with the regulations.

In the same room, wall coverings may be of varying thicknesses. The depth of a wall covering on different base materials can be preset (e.g. thickness 0 on a plasterboard base)

Objects and object types

Extensive information can be found in the Manual and in Chapter 9.3 [Object types](#).

Short summary:

Objects

Objects are individual drawing elements such as construction parts, which can be selected in the CAD using a single click.

Object types

Object types are listed in quantities manager.

Object types map the calculation results for the evaluation.

Object types without reference to an individual object

The floor data object type contains floor calculations such as floor area and volume.

The external surface object type corresponds to the surface of the external wall on the perimeter contour. The object type is displayed by selecting it in quantities manager.

Object types with reference to an individual object

All construction parts, library parts etc. can be displayed by selecting the object type in quantities manager.

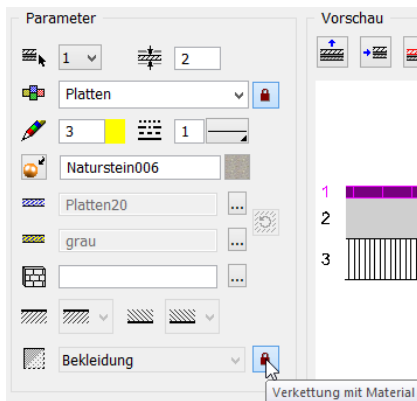
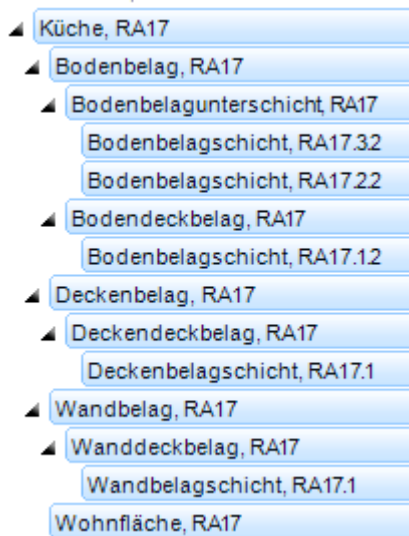

Objects with several object types

Rooms

Room finishes and living space are subordinate to rooms. Room finishes are broken down into covering finishes and the layers underneath.

The layer type (illustration: facing) is set automatically by concatenation with the material

Multilayer construction parts and layer types

With multilayer construction parts, several object types are calculated.

- Each layer belongs to one layer type (e.g. subconstruction)
- Layers in the same layer type are grouped and measured together, if they touch one another and are of the same size.
- In addition, each layer is also measured individually.
- The main object type includes all layers (e.g. wall).
- For walls, facings are measured on the surface, while the other layer types are measured in the centre of the layer(s).

1.3 Diagram: Management using materials

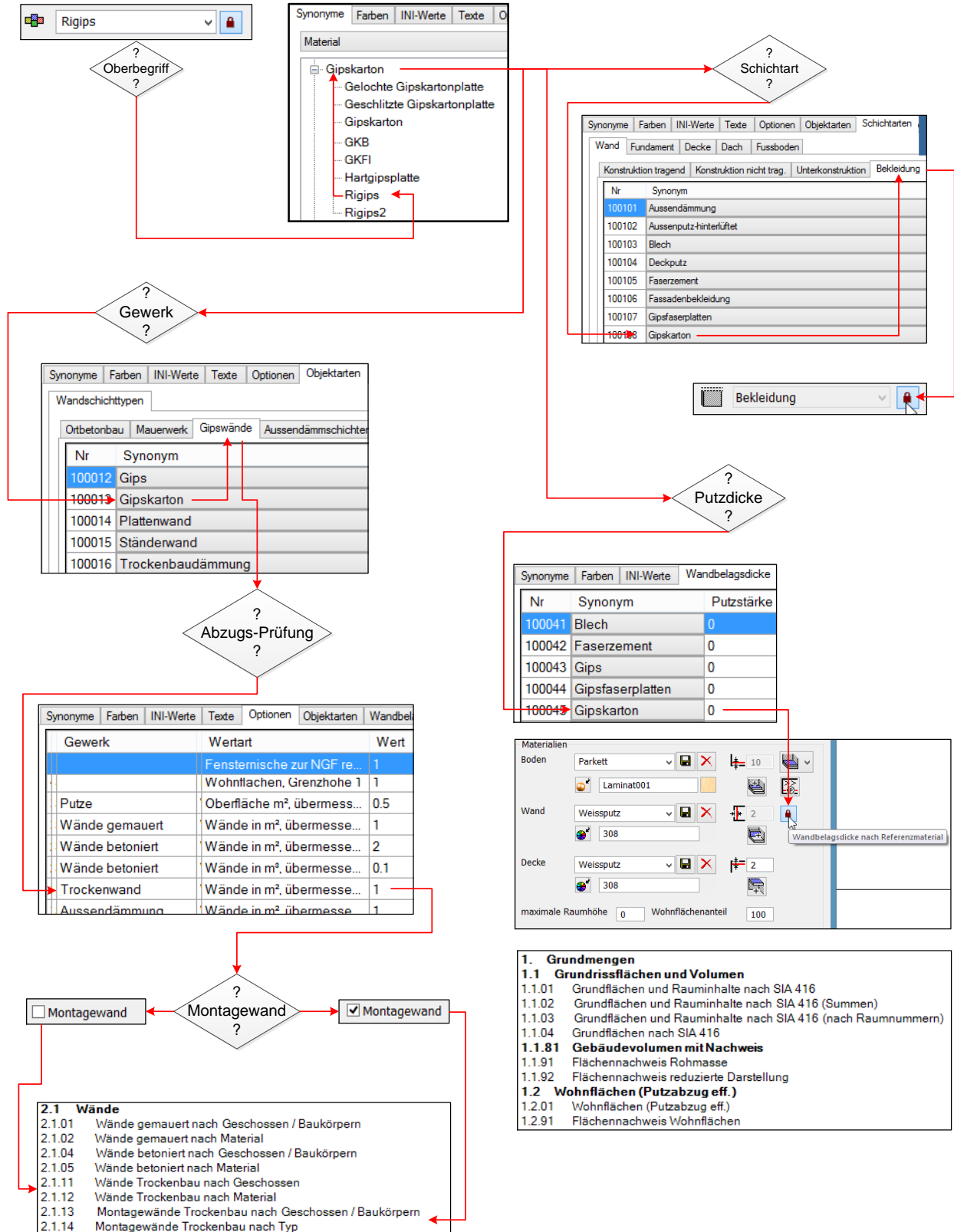

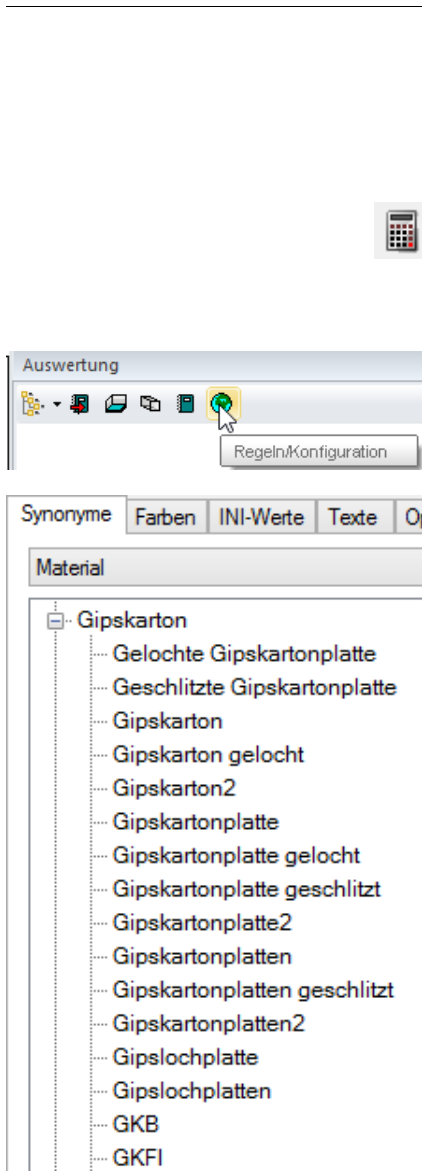

Settings

Quantities manager

Toolbar *Construction parts

Extras menu > Evaluation > Quantities manager

Toolbar > Evaluation > Quantities manager

Rules/Configuration

Synonyms for materials

The synonyms are the central element in EliteCAD and BIM2COST for managing:

- Setting the layer type for multilayer construction parts
- Trades or work type and deduction audit
- Plaster thicknesses on wall sub-bases for calculations of net room area for living spaces and floor plan areas.
- Attribution rules to cost components in BIM2COST

Function:

The materials (synonyms) are subordinated to an overarching term which is used in the model.

The settings are managed in the other registers using the overarching term.

Important:

The program is case-sensitive.

The 'ß' character, which is only used in Germany and Austria, can cause problems. For that reason, all terms are listed using the spelling which is standard in Switzerland.

Layer type

Using the layer type, it is possible to measure layers grouped together.

Presetting the layer type

In the parameter mask, the layer type is automatically preset for all construction parts, with the lock in the closed position.

- Load-bearing
- Non load-bearing
- Subconstruction
- Facing

The lock is only opened if the presetting does not reflect the standard setting.

In BIM2COST, the layer type is changed in the layer editor using the codes K, N, U and B.

Example:

A sand-lime wall can be either load-bearing (presetting) or non load-bearing.

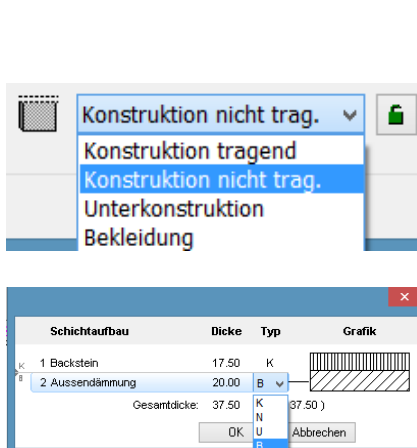

Nr	Synonym
100058	Abdichtungsbeton
100059	Backstein
100060	Beton
100061	Brettschichtholz
100062	Brettspertholz
100063	Dämmung-Balken
100064	Holzbausystem
100065	Holzbausystem-massiv
100066	Holzkastrplatte
100067	Holzrippenplatte
100068	Holzständer-Dämmung
100069	Kalksandstein
100070	Porrenbeton
100071	Stahl
100072	Ständer-Dämmung
100074	Vorfabrikation in Beton + künstl. Steinen
100075	Zementstein



Register of layer types

The overarching terms in the registers for layer types (e.g. load-bearing) are entered in the register of layer types for walls, foundations, slabs, roof and floor.

After this, the layer type is automatically preset in the construction part parameter masks, with the lock closed.

Layer type evaluation

Joint evaluation

Where several adjoining layer types belong to the same layer type and where these have the same dimensions, they are evaluated together.

Example:

On a roof, the tile battening and the counter battening are evaluated together as a subconstruction.

Layer type evaluation Wall

Facings and system-built walls are always evaluated using the wall surface.

The other layer types are evaluated using the middle of all layers.

Object types for layer types

For all construction parts, the four layer types can be preset in the parameter mask (lock in closed position).

For floors, when defining spaces the layer types load-bearing and non load-bearing are not available.

- Load-bearing
- Non load-bearing
- Subconstruction
- Facing

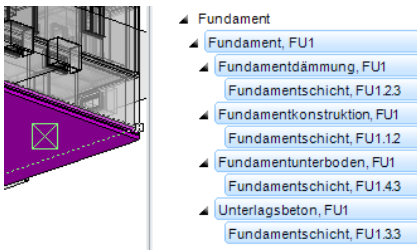

The naming of the object type in quantities manager deviates from the settings descriptions above, for better comprehensibility. The naming of the object types can be influenced via Settings > Texts > Object types.

Overview of object types and layer types

Wall	Object type
Load-bearing	Wall construction
Non load-bearing	Wall construction, non-bearing
Subconstruction	Wall facing subconstruction
Facing	Wall (facing)

Slab, internal + external foundation	Object type
Load-bearing	Floor construction
Non load-bearing	Floor construction, non-bearing
Subconstruction	Floor subconstruction
Facing	Floor facing

Foundation	Object type
Load-bearing	Foundation construction
Non load-bearing	Foundation subfloor
Subconstruction	Socket concrete
Facing	Foundation insulation

Roof	Object type
Load-bearing	Roof construction
Non load-bearing	Roof insulation
Subconstruction	Roof subconstruction
Facing	Roof skin and soffit

Hollow ceiling	Object type
Load-bearing	Ceiling facing subconstruction
Non load-bearing	Ceiling facing subconstruction
Subconstruction	Ceiling facing subconstruction
Facing	Ceiling facing

Floor finish - Room	Object type
Subconstruction	Floor finish sublayer
Facing	Floor covering finish

Wall finish - Room	Object type
Subconstruction	Wall finish sublayer *)
Facing	Wall covering finish

*) Only in BIM2COST

Ceiling finish - Room	Object type
Subconstruction	Ceiling finish sublayer *)
Facing	Ceiling covering finish

*) Only in BIM2COST

Layer type preset for IFC imports

When importing IFC models, the layer type is automatically adopted based on the presets

Materials and trades setting in EliteCAD

The choice of materials for construction parts triggers automatic allocation to the trades or craft type in some cases.

Materials and trades/craft type for CAD floors

- Concrete materials Concrete ceiling
- Other materials without trades/work type

Materials and trades/work type for CAD roofs

- Concrete materials Concrete ceiling
- Other materials without trades/work type

Materials and trades/work type for walls

- Concrete materials Concrete walls
- Brick materials: Brick walls
- Plaster etc. Dry-type construction
- External insulation materials External insulation
- Other materials without trades/work type

Setting for trades or work type

Quantities manager > Rules/Configuration

Example

Select index of object types

Select masonry index

Here, all materials can be listed which are intended to belong to the trade "Brick walls".

Overarching terms are selected here for materials. Sub-terms (synonyms): see next section.

The listing can be amended using the buttons Remove and Add.

The materials listed in the in-situ concrete construction index are also applicable for CAD floors

For detailed explanations, refer to [Options Walls](#) (Chapter 10.3)

Deduction audits for trades

In the options, the values for the deduction audits are entered for walls and wall finishes (plaster):

- Brick walls
- Concrete walls
- Drywalls
- External insulation.

The deductions for the materials listed in the "Other layers" index are checked using the value for brick walls.

For non-listed materials, measured values are used.

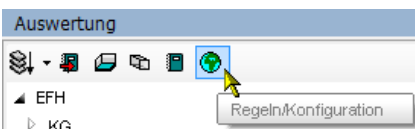
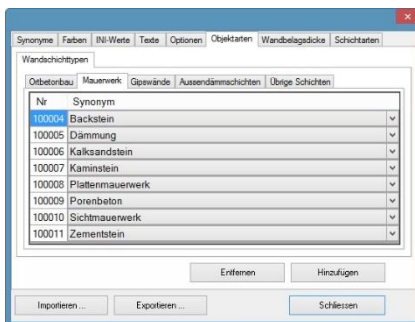

Gewerk	Wertart	Wert
Putze	Oberfläche m², übermessene Öffnungen bis in...	0.5
Wände gemauert	Wände in m², übermessene Öffnungen bis inkl.	1
Wände betoniert	Wände in m², übermessene Öffnungen bis inkl.	2
Wände betoniert	Wände in m², übermessene Öffnungen bis inkl.	0.1
Trockenwand	Wände in m², übermessene Öffnungen bis inkl.	1
Aussendämmung	Wände in m², übermessene Öffnungen bis inkl.	1

rand

System-built walls

The system-built wall option has the effect of evaluating all layers in a wall together.

The measurement is taken on the surface of the wall, on the side of the wall axis drawn.

Use of the system-built wall option

- Partition walls drywall construction
- Prefabricated walls
- Walls in element construction.

It must be remembered that all materials are assigned to either the same trade or none.

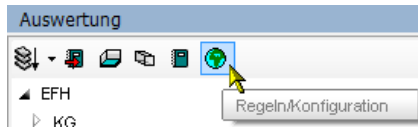

Nr	Synonym	Putzstärke
3000	Gips	0
3000...	Gipskarton	0
3000...	Gipsfaserplatten	0
3000...	Beton	1
3000...	Backstein	2
3000...	Kalksandstein	1.5
3000...	Ständerwand	0
3000...	Plattenmauerwerk	2
3000...	Sichtmauerwerk	0
3000...	Plattenwand	0
3000...	Kabinentrennwand	0
3000...	Porenbeton	1
3000...	Holz	0
3000...	Holzverkleidung	0
3000...	Holzwerkstoff	0
3000...	Glas	0
3000...	Holzwerkstoff	0
3000...	Metall	0
3000...	Kunststein	0
3000...	Naturstein	0
3000...	Trennwand	0
3000...	Trennwand beweglich	0
3000...	Zementstein	1.5

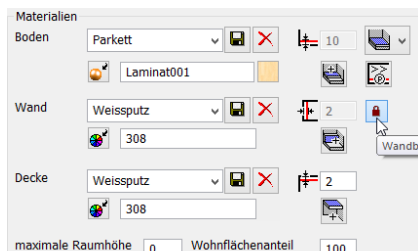

Different wall finish thicknesses for living areas

In EliteCAD AR13, the user can select whether different wall finish thicknesses are to be calculated for different wall materials for the clear areas, e.g. for the calculation of living space. These settings are then applicable for all rooms created with this option.

Setting for wall finish thicknesses

Quantities manager > Rules/Configuration

The wall materials are entered on the list using the Add button. The nominal thickness of the wall finish on the wall material base is set in the 'Plaster depth' column (depending on the CAD setting).

Next, with the lock in the closed position, the finish thickness on the predefined wall materials is calculated in accordance with this preset. On the wall bases not listed above, the greyed value is included in the finish thickness calculation.

The calculated living space can be viewed in quantities manager. This object type is subordinated to the room.

Special materials (insulation, etc.)

Allows for special materials to be included for various trades and layer types.

However, in order for these to be differentiated, they must be specified more accurately through naming.

Insulation for trades***Insulation for walls***

All wall insulations without special descriptions are assigned to the 'Brick walls' trade

Layer type subconstruction

Insulation for roofs and ceilings

Layer type non load-bearing.

(For better differentiation from the other subconstruction, such as laths, etc., since the surface to the subconstruction is widely varying).

Insulation for foundations

Layer type facing

Insulation for floors

Layer type subconstruction

Insulation - beams

Insulation located in the bearing construction layer

Layer type bearing construction

External insulation

Only rendered external insulation.

Trade external insulation

Layer type facing

Insulation - facade construction and insulation laths

For back-ventilated facade facings

Layer type subconstruction

Drywall construction insulation

Insulation for walls in drywall construction, e.g. plasterboard partition walls.

Trade drywall construction

Layer type facing

Partition wall insulation and timber partition insulation

Insulating layers in the load-bearing construction layer of timber walls.

Layer type bearing construction.

Gypsum fibre board

To distinguish from gypsum plaster board as a single overarching term.

Gypsum fibre boards are generally used in timber construction, for which reason this material is not assigned to drywall construction.

Timber

This term should be avoided for spatial construction parts such as slabs, roofs, walls etc.

Timber facing

Layer type facing.

If the timber formwork is a subconstruction, this must be set as such (lock in the open position).

On timber construction ceilings, for better differentiation the roof boarding above the beam should be described as a dead floor.

Timber construction system

Panel construction using non-solid panels (e.g. partition construction)

Layer type bearing construction

Allocation in BIM2COST to cost component element construction in timber

Timber construction system - solid wood

Element construction using solid wood elements (e.g. log wall)

Layer type bearing construction

Allocation in BIM2COST to cost component solid timber walls

Glued laminated timber and glued cross-laminate timber

Load-bearing layers in timber construction

Layer type bearing construction

Allocation in BIM2COST to cost component solid timber walls

Timber box panels and timber ribbed panels

Layer type bearing construction

Timber materials

Excluding wood fibre board, but including laminated timber (not glued cross-laminated timber)

Layer type subconstruction

Wood fibre boards

Layer type subconstruction

Dead floor

Upper subconstruction for slabs

1.4 Preparation and evaluation

Reading in the model

Select the project **CAD_Object_Evaluation**.

There are different standards and materials for each country. Accordingly, for this course unit there is a separate model for each country. The following should be imported:

Switzerland: **Model_Evaluation_CH.d**

Germany: **Model_Evaluation_DE.d**

Austria: **Model_Evaluation_AT.d**

Preparing the model

Perform an AR object refresh for each storey.

The refresh should not be carried out for the course model. This prevents hatchings for materials from being lost.

Quantities manager



Toolbar *Create new AR objects

Extras menu > Evaluation > Quantities manager

Toolbar > Evaluation > Quantities manager

If a list is present in the opened quantities manager, then the model has already been evaluated (see illustration).

Evaluated models can be deleted in [Project Management](#) (Chapter 10).

Evaluating models



Menu Extras > Evaluation > Evaluation in DB

Toolbar Evaluation > Evaluation in DB

Quantities manager > Evaluation in DB

Lists

Detailed information can be found in Chapter 10 [Evaluation options and lists](#)

Walls, slabs and roofs are assigned to a trade or to work type, based on the material, for the evaluation. There is a separate list for each trade or each work type. The deduction audits are taken into account in EliteCAD in accordance with the specifications in the standards.

No deduction audit is carried out in BIM2COST, since the eBKP-H standard does not recognize deduction audits.

1.5 Selection and display

Display

When a storey is selected in quantities manager, it is displayed in solid mode.

The structure is similarly displayed in solid mode.

When an object is selected in the CAD, this is emphasized in the CAD and the display switches to transparency mode.

In quantities manager, all object types belonging to the CAD object are marked.

If an object type is selected in quantities manager, this is displayed in accordance with [Options Colours](#) (Chapter10) in the CAD. The rest of the model switches to transparency mode.

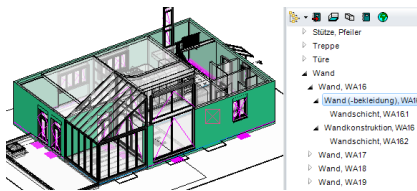

Werte und Attribute		Formeln
Bezeichnung	Wert	
Aussen	Ja	
Bodenfläche	7.7376 m ²	
Dicke	0.160 m	
Fläche	125.6346 m ²	
Fläche unter Terrain	0.0000 m ²	
Geschoss Nr.	0	
Gewerk	Aussendämmung	
im Erdreich	Nein	
Länge	49.000 m	
Layer	Wand	
Materialinfo	Aussendämmung	
Max. Höhe	3.380 m	
Montagewand	Nein	
Volumen	19.6391 m ³	

The results are viewable in quantities manager in the indexes “values and attributes” and “formulae”.

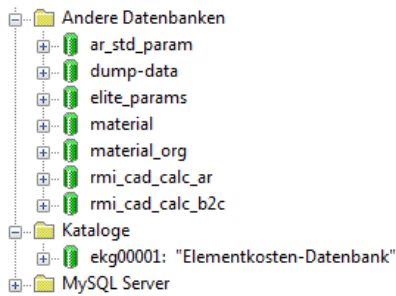

2. Evaluation database

EliteCAD AR13 and BIM2COST 13

The evaluation is carried out in a MySQL database. EliteCAD and BIM2COST in the same version must be managed via the same MySQL server (this is prompted on installation). The MySQL server controls various databases.

The texture database (material) is used by both programs. BIM2COST 13 and EliteCAD AR13 have different evaluation databases:

DB EliteCAD AR13: rmi_cad_calc_ar

DB BIM2COST: rmi_cad_calc_b2c + ekg00001

DB standard values EliteCAD AR13: ar_std_param

DB cost breakdown eBKP-H BIM2COST: ekg00001

Requirement

- Different MySQL servers for different versions
- The same MySQL server for EliteCAD and BIM2COST in the same version
- A different MySQL server must already be (or needs to be) installed for construction admin.

Note Messerli-Bauad and BIM2COST

Messerli-Bauad uses a separate MySQL server.

In BIM2COST, the cost type breakdown (KAG) eBKP-H is used from this database. Thus changes to this catalogue are to be carried out in Messerli-Bauad.

Without Messerli-Bauad, the cost type breakdown (KAG) eBKP-H from the EliteCAD database is used.

The evaluation in BIM2COST is always carried out in the EliteCAD database (corresponds to the BIM2COST database).

The quantities assigned via the allocation rules are then transferred to the Messerli-Bauad database.

Reports

For the lists in EliteCAD AR13 and BIM2COST, the databases belonging to the programs from the MySQL server for EliteCAD are used.

Modifications in BIM2COST

Modifications in BIM2COST are not written to the model, but to the MySQL database. Modifications are retained and do not need to be repeated for each session.

3. Areas and standards

Overview

Rooms

Rooms are formed by room-dividing construction parts. Room definitions must be set into the rooms in order to enable differentiation of areas between storeys and rooms.

Room area

The room area is the net area. The room area is calculated excluding door niches and, depending on the standard, excluding window niches.

Living space

The living space corresponds to an assessed area. The assessment is undertaken in accordance with the standards.

Floor covering area

The floor covering area corresponds to the area which has a floor covering.

Floor covering in EliteCAD

The floor covering can be adjusted in EliteCAD.

Room group

Various rooms can be totalled together using the room group stamp.

Storey area

The storey area is the total of the room areas and the construction area. The storey area is divided internally and externally.

Perimeter contour

EliteCAD calculates the storey area using a perimeter contour. The perimeter contour encloses all room-dividing elements. The division into internal/external must be carried out manually.

Room volume

Storey height (volume)

The height of a storey is calculated using the difference between the lower edges of storey and level floors or the upper edge of the roof.

Net room height (volume)

The height of a room is calculated using the upper edge of the floor covering and the lower edge of the storey floor, level floor, hollow ceiling, roof and height definition.

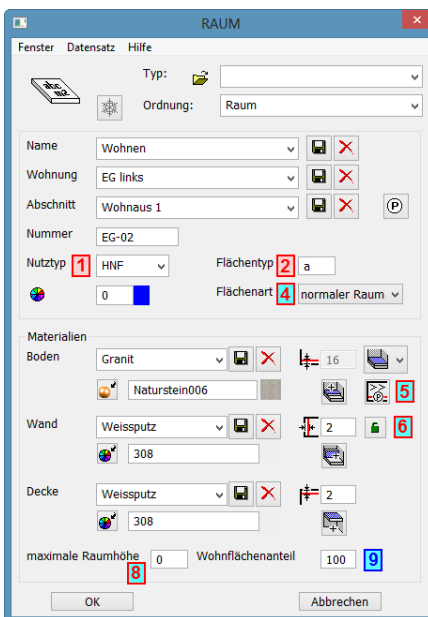

3.1 Room definition

Standards, living spaces and areas

1 Red for border, number and fill:
Only for areas and volumes (DIN277, ÖNORM B1800 und SIA416)

9 Blue for border, number and fill:
Only for living spaces

4 Red for border and number, blue fill:
For living spaces, areas and volumes (DIN277, ÖNORMB1800 and SIA416)

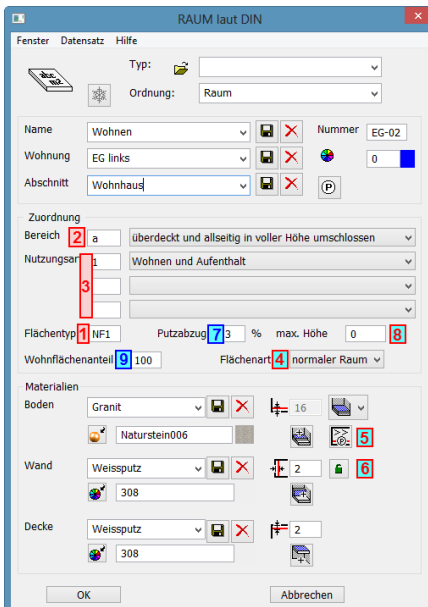

Labels

For the 4 lower fields, the following attributes can be selected.

These can be selected using the  button

areanorm	Evaluated living space incl. height check and percentage deduction for plaster
areanormnew	Evaluated living space incl. height check and measured deduction for plaster
areanorm0	Evaluated living space from living space calculation below limit height 1
areanorm50	Evaluated living space from living space calculation between limit height 1 and limit height 2
areanorm100	Evaluated living space from living space calculation above limit height 2
use	Net storey area type (NGF, Nettogeschossfläche)
areatype	Area (a, b or c in accordance with DIN 277 and ÖNORM B1800)
areapercent	Living space percentage (%)
putzabzug (plaster deduction)	Percentage deduction for plaster in living space calculation (in accordance with the old Second German Calculation Ordinance)
volume	Room volume NRI

No longer supported:

areanorm1	Room area under limit height (DIN277: 1.50 m, old standard)
areanorm2	Room area over limit height (DIN277: 1.50 m, old standard)

The **Calculated Values** are written into the drawing, depending on Settings > Options > Work parameters > Architecture with the option "Immediately update rooms". If this is not enabled, then the value is only written to the drawing after "Evaluation in DB".

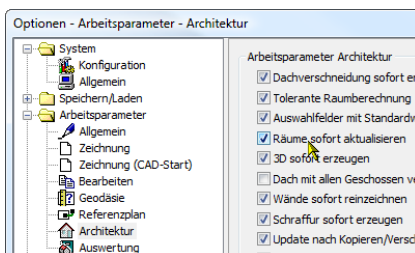
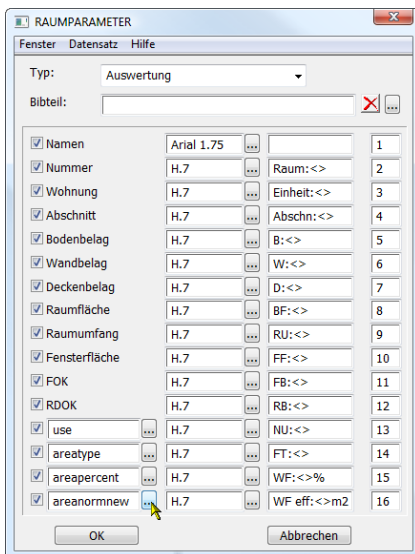

3.2 Room definition, overview

Name (room name)

- EliteCAD AR13 and BIM2COST: Rooms without room definitions are not evaluated.
- In BIM2COST there is an allocation rule for room names kitchen and synonyms to cost component G 5.2. Fitted kitchen
- Minimum room size in EliteCAD AR13
Quantities manager > Rules/configuration > Options
In BIM2COST:
Regulations > Master data > Options
For “trades” shell, room, set minimum room size to 1
Closets are not listed in the reports.
- Regardless of the room size, it is possible to select “Construction area” in [Area type](#), with the effect that it is not listed in any report.
- For air spaces, the [Area type](#) “air space” must be selected.

Unit

- Room group name for units, shop areas, etc.
- Term for room groups in reports: UNIT.
- Terms can be changed for all reports. See [Text changes in lists](#) (Chapter 10.2).
- The name for each room group needs to be unique. In the reports, the rooms are sorted by room groups and the results totalled together.

Section

The name of the section is exported to the room register, but is not listed in the reports.

Number

Room number

Stammdaten					
Synonyme Farben INI-Werte Texte Optionen Objektarten					
Id	Norm	Gewerk	Objektart	Wertart	Wert
51	SIA deutsch			Ergebnis aus Formel	1
49	SIA deutsch			Formelgenauigkeit	3
48	SIA deutsch			Wertgenauigkeit	4
50	SIA deutsch			Winkelgenauigkeit	1
450	SIA deutsch	Holztr...	Dachstuhl	Querschnitts-Grenz...	0.01
448	SIA deutsch	Holztr...	Dachstuhl	Überlänge ab	8
675	SIA deutsch		Raum	Berechnungsergeb...	0
47	SIA deutsch		Raum	Faktor über Grenzh...	1
45	SIA deutsch		Raum	Faktor unter Grenzh...	0
46	SIA deutsch		Raum	Faktor zwischen Gr...	0.5
193	SIA deutsch		Raum	Fensterische zur N...	1
173	SIA deutsch		Raum	Mindestraumgröße	1
183	SIA deutsch		Raum	Minimale Nischenti...	0.001
42	SIA deutsch		Raum	Wohnflächen, Gren...	1
43	SIA deutsch		Raum	Wohnflächen, Gren...	2
366	SIA deutsch	Ausse...	Wand (-b...	Wände in m², über...	1
298	SIA deutsch	Trock...	Wand (-b...	Wände in m², über...	1
268	SIA deutsch	Wänd...	Wand (-b...	Wände in m², über...	2
269	SIA deutsch	Wänd...	Wand (-b...	Wände in m², über...	0.1
35	SIA deutsch	Wänd...	Wand (-b...	Wände in m², über...	1
37	SIA deutsch	Putze	Wandbel...	Oberfläche m², über...	0.5

Nutztyp	HNF
---------	-----

Flächentyp	NF1
------------	-----

1 Use type. Attribute for use

Use type (not Germany)

Area type (Germany)

Only for areas and volumes

The use type is saved in the database ar_std_param specific to the country and region. These can be changed via the menu Extras > Settings > Room use.

For the evaluation, the specified values of the standards for areas are taken into account.

For entries not covered by standards, evaluation to comply with standards is not possible.

Net area NGF DIN 277 (2005):

NF, TF, VF

Subdivision of floor space (NF)

Floor space (Nutzfläche, NF) is broken down using the [Use type](#): NF1, NF2, NF3, NF4, NF5, NF6 and NF7

In the lists, NF1 to NF7 are listed individually and combined to create the floor space NF.

Net area NGF ÖNORM B1800 2002:

HNF, NNF, FF, VF

In the lists, HNF and NNF are listed individually and combined to create the floor space NF.

Net storey area NGF SIA416:

Internal areas: HNF, NNF, FF, VF

External areas: ANF, AVF, AFF

French-speaking Switzerland: SUP, SUS, SI, SD; SEU, SEI, SED

In the lists, HNF and NNF are listed individually and combined to create the floor space NF.

- Non-standardized values are also included in the total.
- SIA 416 report: Internal areas and external areas are totalled separately, if standardized values were selected.
- Room label: Use marking.
- Standardized values are totalled in EliteCAD AR13 and BIM2COST to create the storey data (object type) and shown in the lists in EliteCAD and BIM2COST and totalled at the storey level.

Nutzungsart	1	Wohnen und Aufenthalt
	1.1	Wohnräume

3 Use groups DIN 277-2 (2005)

(only country setting Germany)

The numberings and standard texts can be selected using the selection button. These are saved in the database ar_std_param. These can be changed via the menu Extras > Settings > Room use.

Flächentyp

Bereich

überdeckt und alle

2Area

Area type (not Germany)

Area (Germany)

Only for areas and volumes

DIN 277 + ÖNORM B1800 for differentiation between internal and external areas. Standardized values:

- a covered and enclosed on all sides to full height
- b covered, not enclosed on all sides to full height
- c not covered.

- The reports DIN 277 and ÖNORM B1800 are totalled using these three values.
- If a field is empty, Type a is assigned in the room register.
- Non-standardized values are not totalled by areas in the report.
- Country setting Germany: The three values with the description can be selected using the selection button. These are preset with the standard values in the database ar_std_param.
- For SIA416, these values have no meaning.
- Room label: Marking areatype.

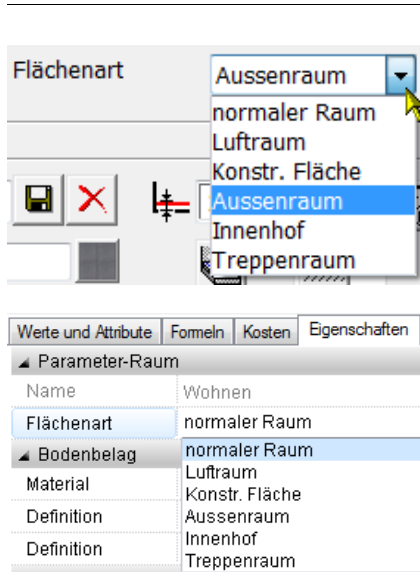

4 Room types (area type)

The area type influences the evaluation for the areas in accordance with DIN 277 etc., living spaces and room surfaces.

Area type in BIM2COST

The area type can be changed in BIM2COST.

Area types

Internal areas

Internal areas must be defined as “normal area”.

External areas

External areas must be defined for BIM2COST as an external area. In BIM2COST, external areas are not calculated for the energy reference area.

Interior courtyards

An interior courtyard is a special external area which is, however, enclosed on all sides by rooms (or room-limiting elements). So that EliteCAD and BIM2COST can identify interior courtyards, for interior courtyards a room description with the area type interior courtyard must be set on all storeys. If this is done, the area is not included in the storey area.

Air spaces

Air spaces must be defined as “air space”.
(Air spaces have no floor).

Exception:

An air space adjoining a roof (over its full height) may **not be defined as an air space**.

No room description is to be set.

The volume lying under the roof and the room finishes are assigned automatically to the room beneath in such instances.

In the evaluation, no floor plan areas are calculated for air spaces, but the volume from the lower edge of the storey ceiling is calculated.

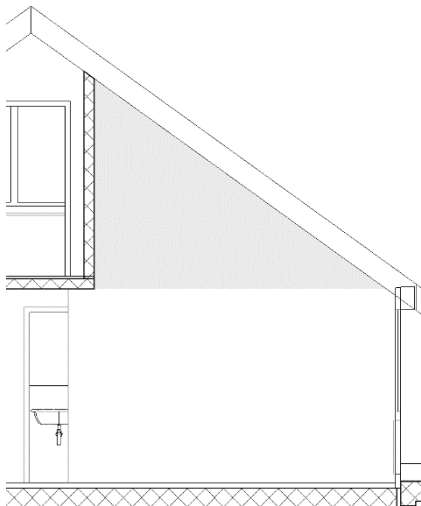

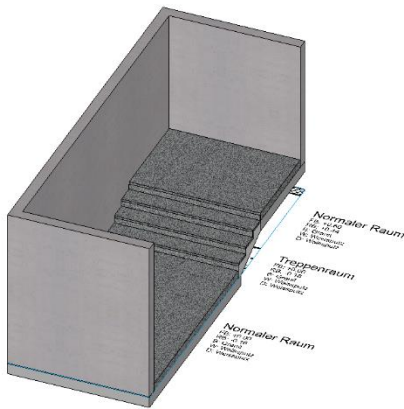

Construction area

Rooms which are to be counted as part of the construction area must be defined with the area type construction area.

Staircase

Special case for runs of stairs between rooms in the same storey: If a room area with different levels is located on the same storey and the different levels are connected via stairs, then the type stair area must be selected over the stairs.

At the different levels, in each case a room definition with the type “normal room” is selected (the room areas are to be separated using room dividers).

Area types for stairs

See also the example in the model for the course unit, section

[Rooms for stairs](#)

In accordance with SIA 416, DIN 277 and ÖNORM B1800 the stairs are calculated in each case in the upper storey. Accordingly, the room definition must be set in the upper storey.

Area types for runs of stairs and landings

For runs of stairs and landings, a room description with area type “normal room” without floor height is set.

Area types in the stairwell

Depending on the provisions in the standards, a room description with the area type air space must be set in the stairwell.

However, on narrow stairwells in accordance with the illustration from SIA416 the area can be counted together, meaning that a single room definition above runs of stairs, landings and stairwells (including to the side) is permitted. The area type “normal room” with floor height 0 must be selected.

On ArchiCAD models, a room definition with room level at the upper edge of the storey ceiling and floor thickness 0 must be set before export to an IFC model.

Area types at storey height

In stairwells, a normal room definition with area type normal room must be set at storey height above the storey landing.

Room definition in the lowest storey

Since for stairs a room definition must be set in the upper storey, a special room definition in the lowest storey in the stair area is not required. A normal room definition is set, which can also extend to the adjoining landings/corridors.

Area types for shafts

For shafts, the following area types are available:

- Air space
- Construction area

Lift shafts, lifts**SIA416 + DIN277**

In each storey, a room definition must be set with the area type “normal room”, but with floor height 0

ÖNORM B1800

The area is only counted at the lowest support. A room definition is set there with the area type “normal room”, but with floor height 0.

On the other storeys, a room definition with area type air space must be set.

Other shafts

In most cases, shafts must be counted as part of the area in all standards. This is achieved using a room definition with area type “normal room”.

However, if the shaft is to be included in the construction area, then no room definition must be set, or alternatively one with area type “construction area”.

Living Space Ordinance (WoFIV) Germany

In order that the area is not counted as living space, the figure 0 (%) is entered for the percentage of living space.

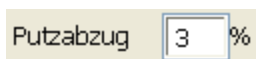
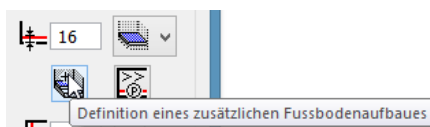
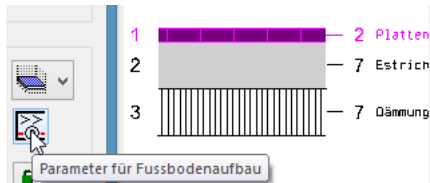
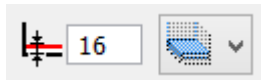

Additional entry fields for room definition

5 Floor covering depth and layer construction

Floor covering depth

The floor covering depth reduces the room height and thus influences the volume and the living space. Select thickness 0 above runs of stairs. The volume of the stairs reduces the space.

Floor construction (floor covering)

The floor covering thickness must correspond to the total thickness of the floor covering.

Additional floor construction

For an existing room definition, the topmost covering layer can be changed using the “Definition of an additional floor construction” button, or an additional covering layer on top can be created.

6 Plaster depth

The plaster depth is used to determine the net room space. These are issued for living spaces and for the area lists.

Plaster depth dependent on wall material

If the button to the right next to the input field is locked, then the plaster thickness or covering thickness proceeds in accordance with the set values, [Index of wall covering thickness](#), so long as the wall material and the covering thickness are recorded in the list.

On the other walls, the covering thickness of the room definition (illustration) is then calculated.

This means that different wall covering thicknesses can be taken into account for the room area calculations (e.g. living space).

Additional/Deduction area

If an additional wall covering is recorded using the button below the input field for plaster thickness, then the thickness entered is taken into account for the living space calculation.

7 Deduction for plaster

Only for living space, Germany. In accordance with invalid standard “2nd Calculation Ordinance”.

- Room label: Marking deduction for plaster.

maximale Raumhöhe

0

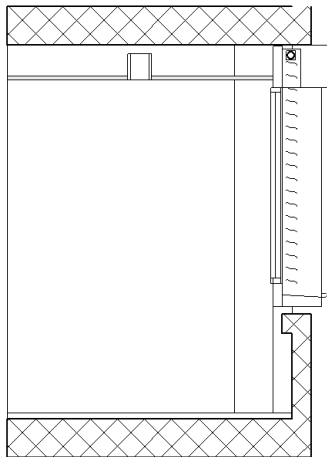

Wohnflächenanteil

100

8 Max. room height

For areas (e.g. DIN 277) and living spaces.

- If no maximum room height is entered (0), then the room height is measured without limit.
- Wall coverings are calculated to the upper edge of the shell floor.
- The volume between the maximum room height and the storey height is evaluated as construction volume. Accordingly, the maximum room height does not reduce the volume of the building.
- For external areas, the room height must be limited with height definitions.

Example: [Room coverings with maximum room height](#)

9 Living space percentage

Only for living spaces.

Evaluation factor of room areas, according to room type.

Note regarding the standards:

- DIN 277: This standard does not recognize assessed living spaces, but all areas are calculated.
- The living spaces ordinance (WoFIV) in Germany requires every area to be evaluated.

• Setting options

- Living space percentage in accordance with WoFIV 0-100%, depending on room type.
- For the options in quantities manager, the limit heights are set with the corresponding factors.

WoFIV:

Parts of the room under 1 m height are not counted as living space.

Parts of the room between 1 and 2 m are calculated using the factor 0.5.

Parts of the room above 2 m in height are calculated in full.

- The area type "air space" is evaluated as 0% living space percentage.
- In the options, the minimum window niche depth can be set:
 - 0 m: niches are not evaluated.
 - 0.13 m: Pre-set for Germany in accordance with WoFIV
 - 0.001 m: Example for minimum value, so that the niches are evaluated.

3.3 Room group

Toolbar *Create new AR objects

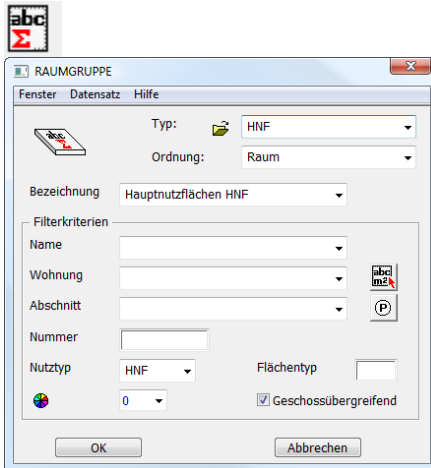

Using the room group, calculations from different room definitions can be summarized together.

Type: A setting can be saved using the Dataset menu.

Designation: Title of the room group stamp

Filter criteria:

- Name: Room name
- Unit
- Section
- Number (room number)
- Use type NGF
- Area type (Area a, b, c. Germany + Austria)
- Across storeys (restricted to structure).

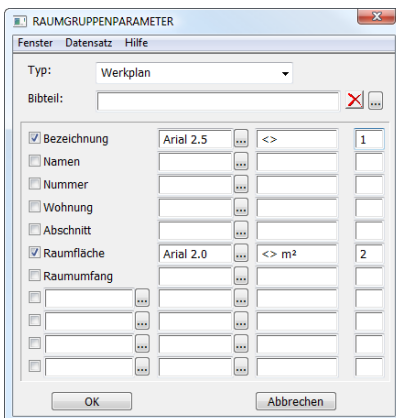

Labelling parameters

Type: If the imaging depth is changed, the corresponding parameters are also changed.

- Label (title of the room group stamp)
- The rest by analogy with room definition

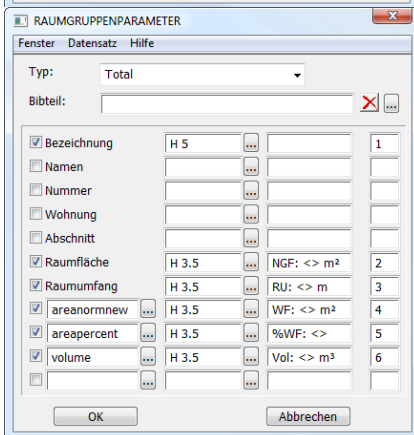
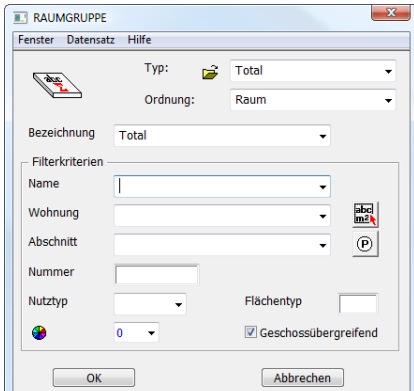

Examples of room groups

Totals

Any room group stamp - title, e.g. "Total Structure 1"

If nothing is entered for the filter criteria, then all are selected.

If across storeys is enabled, all storeys in the structure are calculated. The room group stamp can be set in any storey, including the level "without storey".

Labelling parameters:

Room group stamp-title

Area and perimeter

Living spaces (evaluated) and percentage share by reference to all areas

Volume NRI or NGV

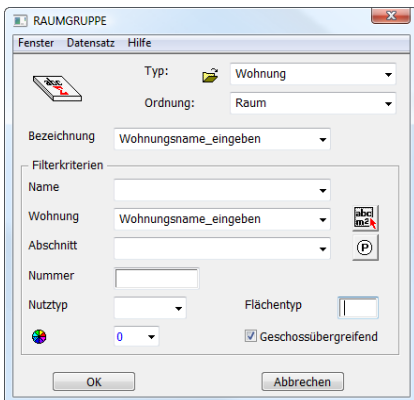

Unit

Room stamp title (any designation), e.g. "4 1/2 - room flat, 1st floor left"

Filter:

Flat name in accordance with room definition

Cross-storey enabled

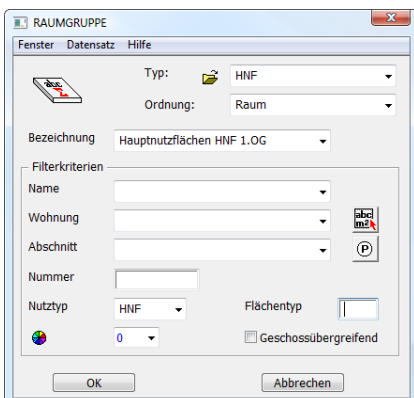

Floor space storey

Title, e.g. "Main floor space HNF, 1st floor"

Filter:

Use type, e.g. HNF

Cross-storey not enabled.

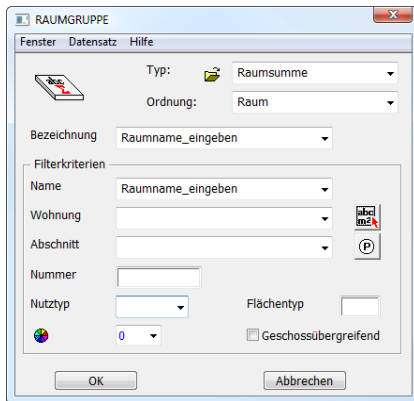

Room total

If several room definitions need to be set in one room (examples: rooms with different levels, rooms with inclined floor screed with different inclines or directions of slope), then these can be summarized into one room group stamp, with the exception of the room facings.

Room group title (as preferred), e.g. “covered parking area”

Filter:

Room name in accordance with room definition

Notes

In the event of adjoining room definitions (with the same names), no perimeter is calculated for the room division.

In the evaluation lists, the room group stamps are not taken into consideration. If a room is subdivided with two room definitions, two rooms are also calculated.

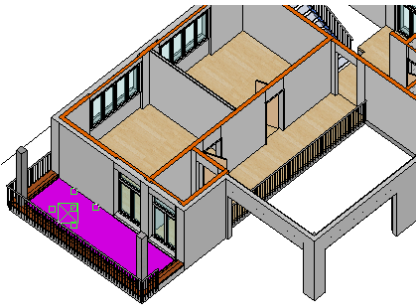

Flächenart

Nutztyp

b

Zuordnung	
Bereich	<input type="text" value="b"/> überdeckt, je
Nutzungsart	<input type="text" value="line1"/>
	<input type="text" value="line1"/>
	<input type="text" value="line1"/>
Flächentyp	<input type="text" value="NF1"/> Putzab:
Wohnflächenanteil	<input type="text" value="50"/>

3.4 External rooms

Covered external rooms

Model: Structure EFH, Terrace

- In the room definition, always select type external room. In BIM2COST, for external rooms there is no allocation to cost components wall facings and ceiling facings. For floor coverings, there is an allocation to flat roof facings.
- Use type SIA 416 ANF, AVF or AFF. If the use type is chosen incorrectly, the external storey area cannot be calculated correctly.
- Use type ÖNORM B 1800 HNF and Area Type b (covered). If the area type is chosen incorrectly, the net area of Area b cannot be calculated correctly.
- Area DIN 277 b (covered)
- Area type DIN 277 in accordance with standard, e.g. NF1
- Living area percentage in accordance with WoFIV, usually 50%

Non-covered external rooms

SIA 416: as for covered external rooms.

DIN 277 and ÖNORM B1800: Area c instead of b.

Room volume for external rooms

Height definition

Limited effect of height definitions and room heights

New feature in EliteCAD AR13:

- The height definition does not limit the room height for living space calculations.
- The height definition limits the room height for the net and gross room volume in accordance with standards DIN 277, ÖNORM B1800 and SIA 416.

Since the specifications in the standards vary and in some cases are also interpreted differently, the room volumes must be limited manually. For this, the umbrella function with thickness 0 and 3D colour 0 is used.

In order that these are easier to edit, they have been stored in the course model in the layer height definition.

In addition, a roof hatching has been used with the name Zero roof and with the pen zero, which is not printed out.

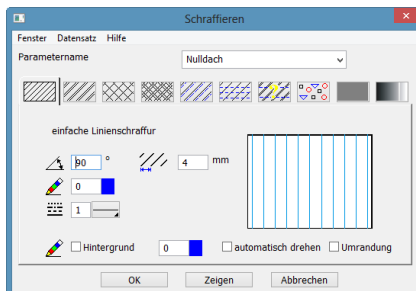

In the detailed parameters for height definitions (roof), Zero roof has been selected for the area beneath this hatching parameter.

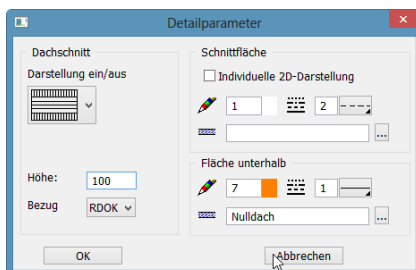

Volume calculation in EliteCAD

If an upper room conclusion via a roof, storey or level floor is missing, CAD calculates the height based on the storey setting. The gross room volume cannot be limited using the maximum room height for the room definition.

Room volume external rooms SIA 416

According to the requirements of SIA 416, for external areas only the construction volume is to be calculated.

This is achieved by setting a height definition at the upper edge of the floor and the upper edge of walls.

Room volume external rooms DIN277 + ÖNORM B1800

In accordance with the requirements of these standards, for Area b covered the normal room height must be calculated. Thus in the first upper storey no measure is required.

In Area c (not covered), the room must be limited at railing height. The height definition must be dragged over the walls.

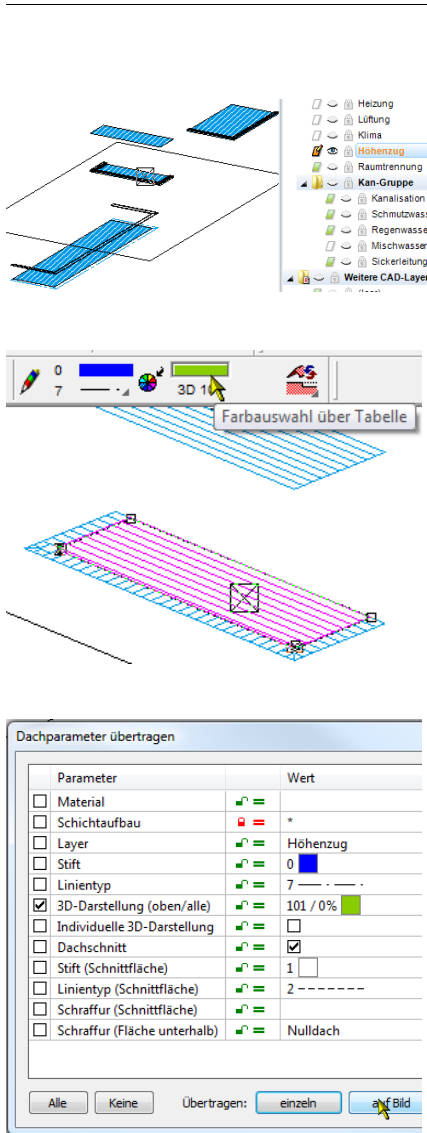

3D check on height definitions

Set up layer height definition in all storeys.

Note:

In the Switzerland evaluation model the parapet coverings are drawn as a roof in the layer, and as a result the specifications of SIA 416 are satisfied for the external construction volume.

In order for the location of these height definitions in the space to be made visible, the 3D colour on an individual height definition is changed temporarily.

Transfer 3D representation on screen or for the Switzerland evaluation model individually.

Model Switzerland

When zooming, interferences form between the 3D colour of the height definition and the room floor or the upstands (wall) when concluding with a flat roof.

Note

If despite the specification in the standard a net room volume is preferred, the height definitions must be set to the desired height. In the lists for SIA 416, the unofficial volume is then accordingly taken into account under external net building volume ANGV and external building volume AGV.

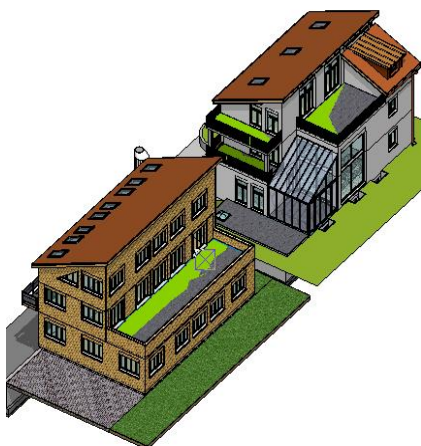

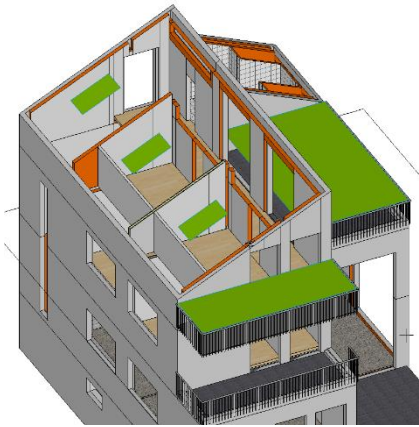

Model Germany + Austria

In addition, also set up an empty layer

The height definitions limit the volume above the non-covered Areas c.

3.5 Storey areas in the standards

SIA416

GF

The storey area (Geschossfläche, GF) comprises only the internal rooms (NGF, net storey area) and the walls and constructions limiting the internal rooms (KGF, construction area).

AGF

The external storey area (Aussengeschossfläche, AGF) comprises the external rooms (ANGF - external net storey area) and the walls and constructions limiting the external rooms (Aussen-Konstruktionsfläche, AKGF), where the latter do not form part of the storey area GF. However, without manual perimeter contour AGF these are not included in the count.

The storey area is not yet divided in the current versions BIM2COST R3.

In EliteCAD AR13 and BIM2COST R4 and above, rooms with external labels ANF, AVF, AFF are automatically counted in the external storey area AGF and the external net storey area ANGF.

Manual perimeter contour

With the manual perimeter contour, the construction areas can also be assigned to the external storey area ANGF.

See [Perimeter contour](#) (Chapter 3.7)

DIN 277 and ÖNORM B1800

BGF

The gross floor area (Bruttogrundfläche, BGF) comprises all internal and external areas (NGF) and all internal and external construction areas (KGF). These areas are divided into the areas:

a Internal rooms

b External rooms covered

c External rooms not covered:

BGFa, BGFb, BGFc, KGFa, KGFB, KGFC, NGFa, NGFb, NGFc

Manual perimeter contour

Using the manual perimeter contour, the construction areas can also be assigned to External Areas b and c.

See [Perimeter contour](#) (Chapter 3.7)

Reports and area labels

The reports are created in such a manner that standardized area labels must be selected for the area types and use types.



3.6 Room + storey in quantities manager

Living space

Living spaces are described in the Chapter [3.8 Living space and verification](#)

Room finishes

Room finishes are described in Chapter [4. Room finishes](#)

Construction parts toolbar

Extras menu > Evaluation > Quantities manager

Toolbar > Evaluation > Quantities manager

Storey in quantities manager

Display mode hierarchy

New mode in EliteCAD AR13

When you select the storey or structure the calculated values are listed in the tab Values and Attributes.

When selecting the structure, the total for all storeys is listed for the values.

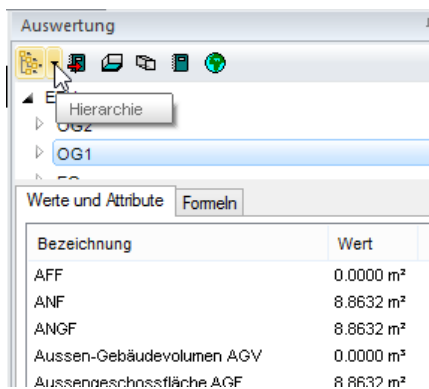

Display mode structure

When you select the storey or structure the calculated values are listed in the tab Values and Attributes.

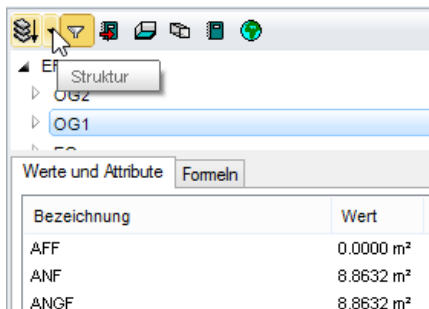

Display mode object types

With the object types mode, the structure is not displayed. At the top, the storeys of the first structure are listed.

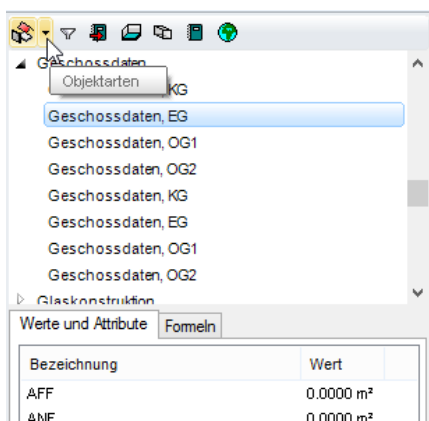

The room in quantities manager

Mode hierarchy

Select structure

The storeys are subordinate to the structure

The rooms are subordinate to the storey

Select room

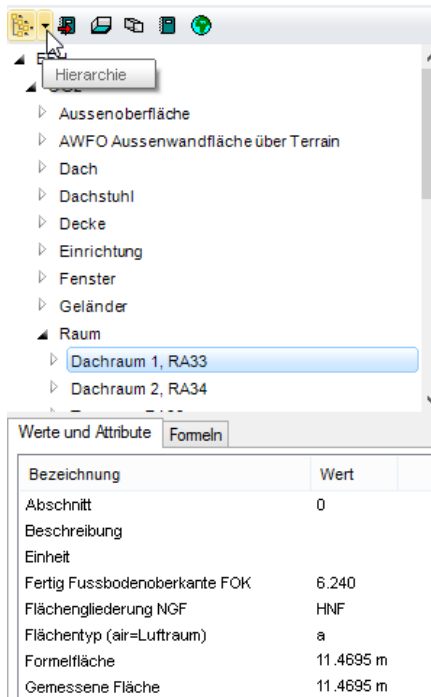

Room finishes

The room finishes are subordinate to the room

The layers are subordinate to the higher-level grouping finish sublayer and covering finish

Selection in quantities manager displays these in the CAD

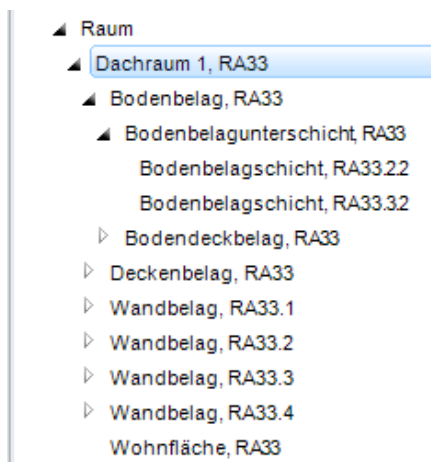

Living space

The living space is subordinate to the room

Display

Example floor covering finish

Example living space

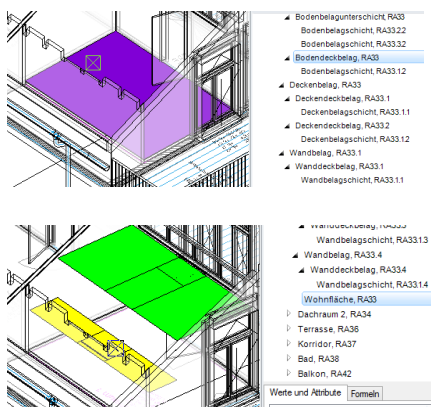

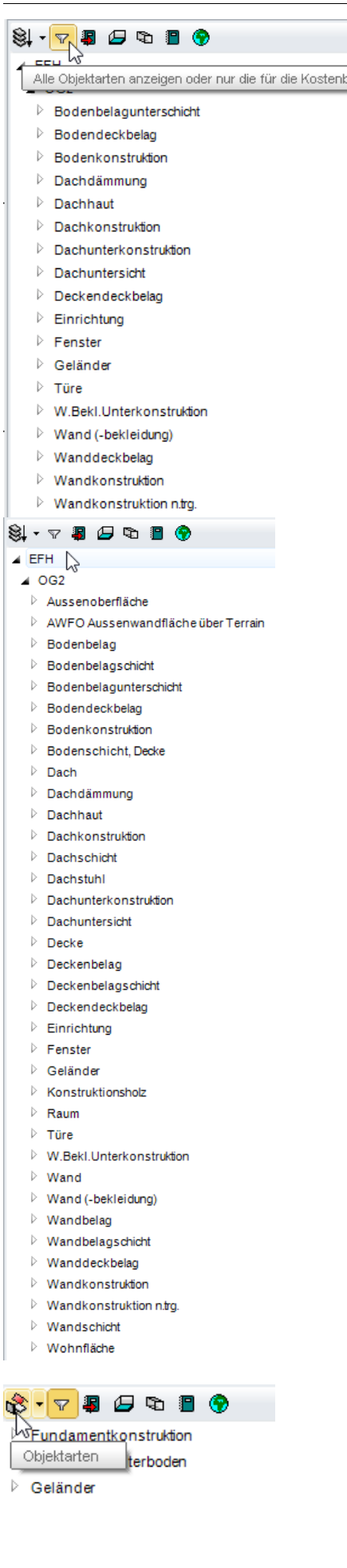

Display mode structure

With the structure display, the individual layers and the living spaces are hidden using the active filter for object type display. It is optimized for BIM2COST display type (cost estimate)

Filter disabled
Display of all object types

Display mode object types

The display type with filter function is similar to the structure display mode, but without a breakdown into structures and storeys.

Werte und Attribute		Formeln
Bezeichnung		Wert
#C		Raum
#G		Raum
#L		AR
Abschnitt		
Einheit		
Fertig Fussbodenoberkante FOK		0
Flächengliederung NGF		HNF
Flächentyp (air=Luftraum)		a
Formelfläche		30.82594
Gemessene Fläche		30.82562
Geschoss Nr.		0
Höhe		3
Layer		Raum
Lichte Raumfläche laut Norm		30.97787
Lichte Raumfläche über Grenzhöhen		30.50327
Lichte Raumfläche unter Grenzhöhen		0
Lichte Raumfläche zwischen Grenzhöhen		0
Minimale Raumhöhe		2.8
Name		Essen
Raumnummer		EG-01
Raumumfang		21.962
Rohe Deckenoberkante RDOK		-0.16
Rohe Raumfläche laut Norm		30.82562
Rohe Raumfläche über Grenzhöhen		30.826
Rohe Raumfläche unter Grenzhöhen		0
Rohe Raumfläche zwischen Grenzhöhen		0
Volumen		90.48626
Wandbelagsdicke		0.02
Wohnflächenanteil %		100

Values for object type room

For the object type room, all room information is listed.

Room area according to standard: DIN277, ÖNORM B1800 and SIA416

Room areas for limit heights: Unevaluated living space

Room area according to standard: DIN277, ÖNORM B1800 and SIA416

Room areas for limit heights: Unevaluated living space

Werte und Attribute		Formeln
Bezeichnung	Ansatz	Wert
RA3.1	9.953	9.953
RA3.1	20.873	20.873
Rechteck	3.747×6.025	22.57568
Dreieck	$(0.719 \times 0.253) / 2$	0.09095
Dreieck	$(0.253 \times 0.203) / 2$	0.02568
Rechteck	1.633×3.850	6.28705
Trapez	$(0.200 + 2.175) \times 1.583 / 2$	1.87981
Kreissegment	$1.150^2 \times (38.72^\circ \times \pi / 180 - \sin(38.72^\circ))$	-0.03323

For the formulae, the measured areas (RA) and the plane verification are listed.

3.7 Perimeter contour

Menu AR objects > Perimeter contour

When evaluating, the CAD creates an (automatic) perimeter contour in each storey. The perimeter contour comprises the outer room-dividing elements.

The perimeter contour forms the basis for:

- Gross floor area BGF as the total of a, b and c in accordance with DIN 277 and ÖNORM B1800
- Total of storey area GF and external storey area AGF in accordance with SIA 416

The areas can be divided up using the perimeter contour function.

Calculation of areas without adjustments

Area a (Germany and Austria)

Net floor area NGFa: Total of all rooms in Area a

Gross floor area BGFa: All areas

Construction surface area: Difference BGFa-NGFa

Area b (Germany and Austria)

Net floor area NGFb: Total of all rooms in Area b

Gross floor area BGFb: Total of all rooms in Area b

Construction surface area: 0 (no areas)

Area c (Germany and Austria)

By analogy with Area b

Storey area GF (Switzerland)

All areas

Net storey area NGF (Switzerland)

All rooms labelled internal rooms in accordance with the SIA standard

Construction surface area KGF (Switzerland)

Difference between all areas - NGF

External storey area AGF (Switzerland)

All rooms labelled external rooms in accordance with the SIA standard

External net storey area ANGF (Switzerland)

All rooms labelled external rooms in accordance with the SIA standard

External construction surface area AKF (Switzerland)

0 (no areas)

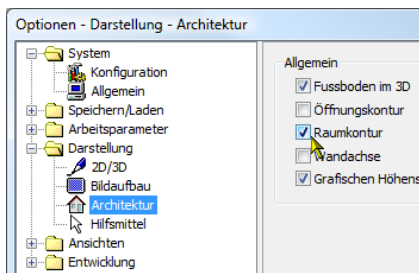

Edit perimeter contour

Evaluation after changing perimeter contours

After altering perimeter contours, a re-evaluation is required in accordance with the following section.

Requirement

1. Room and perimeter contours must be switched on:

Menu Settings > Options > Display

Under Display > Architecture, enable the room perimeter option.

2. The model must be evaluated (otherwise no perimeter contours are present)

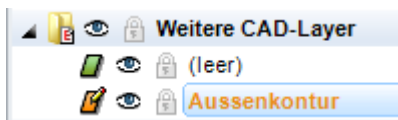

Setting up a perimeter contour

The perimeter contours are located in the perimeter contour layer. These should be set up together with the walls (wall layer) and other room-dividing construction parts.



Adjusting the automatic perimeter contour

The properties toolbar is displayed simply by selecting the perimeter contour.

Simply by selecting the perimeter contour, the input aids for editing the perimeter contour like a polygon are displayed.

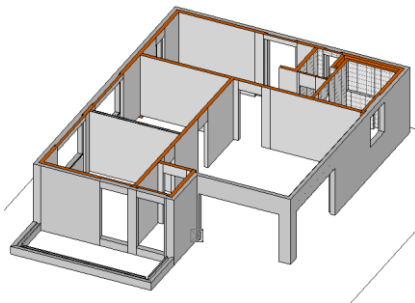

Area a (DE + AT) or GF (CH)

The Automatic Perimeter Contour is taken back to the internal area using the normal editing functions for polygons:

- Germany and Austria Area a for BGFa
- Switzerland Storey area GF

In the 1st upper storey, set up layer perimeter contour and wall. Hide the parapet on a terrace and switch to the wireframe model.

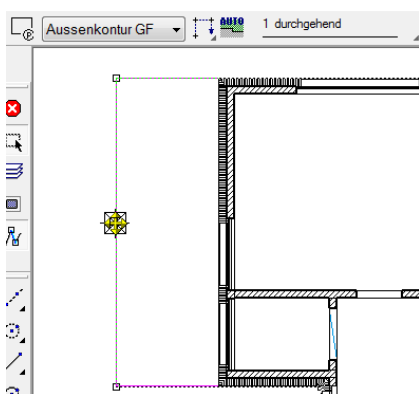

Select the perimeter contour in the CAD (in the parapet area).

In the properties toolbar, the automatic perimeter contour is displayed with the coloured symbol.

Switzerland: Perimeter contour GF (illustration), Austria and Germany: Perimeter contour a (illustration on previous page).

Now the perimeter contour is taken back to the right to the external facade. This converts it to a manual perimeter contour.

Creating manual perimeter contours

After the automatic perimeter contour has been changed, it is converted into a manual perimeter contour.

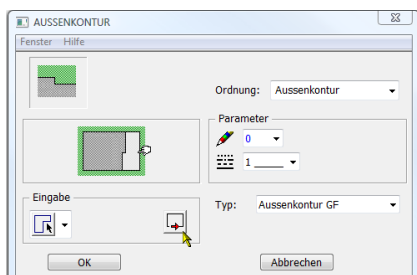
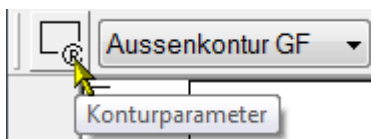
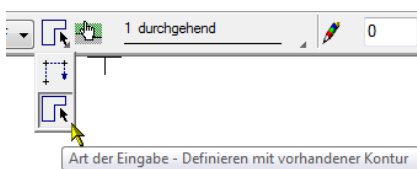
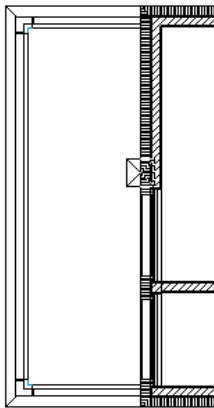
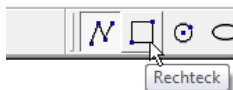
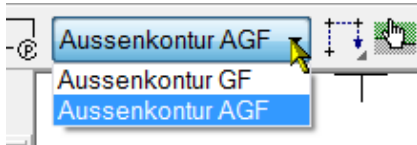
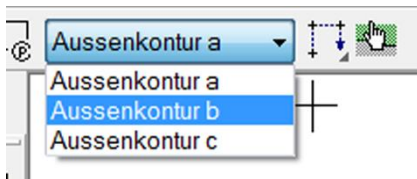

Drawing perimeter contours for external areas

Menu Extras > AR objects > Perimeter contour

1st upper storey

Germany + Austria: Select Perimeter Contour b.

Switzerland: Select Perimeter Contour AGF.

Use the drawing function rectangle to draw the external area.

Labelling the manual perimeter contour

If a contour has previously been drawn using the 2D functions, this can be labelled as a perimeter contour by switching to the properties toolbar.

Calculating the perimeter contour automatically (without previous evaluation)

The perimeter contour parameter mask must be opened.



Using the "Calculate perimeter contour automatically" button, the CAD creates a perimeter contour around all room-dividing construction parts, including those not built up.

3.8 Plane(s) verification rooms

Graphical planes verification

Settings

Menu Settings > Options

Work parameters > Plane(s) verification

Text parameter(s)

Pens for surface contour and for deductions

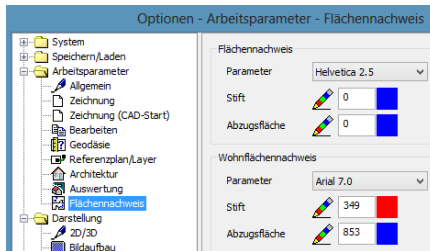

Create

Menu Extras > Evaluation > Plane(s) verification

Toolbar Evaluation > Plane(s) verification

Determine selection

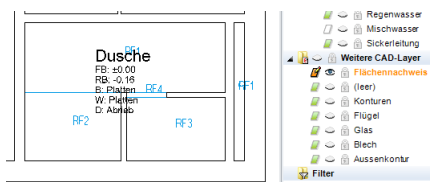

The contours are created in the plane(s) verification layer.

The display of part areas and their docu-texts are carried out in accordance with the settings.

The room-dividing construction parts are created using Pen 5.

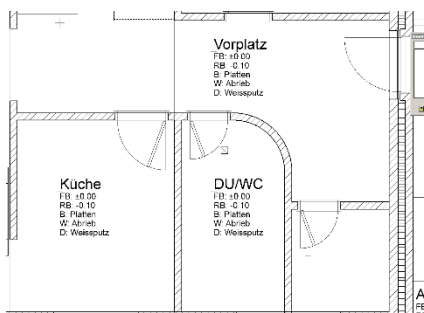

- For the plane(s) verification list, graphical plane(s) verification in the CAD is not a mandatory requirement.
- Using "Model Information", the calculation can be checked in the drawing.

In the example here, the colouring demonstrates how the areas are calculated.

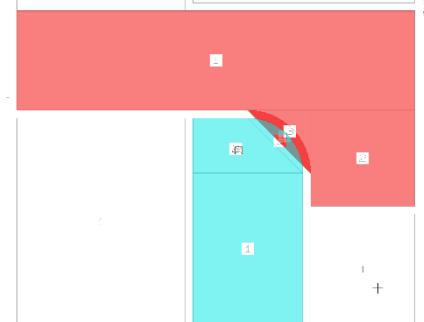

Plane(s) verification list

1.2.91 Plane(s) verification rough dimensions

Objekt-Unterart (obkind) : Rechteck
 Flächenberechnungsformel (formular) : 2.332 x 1.705
 Fläche (area) : 3.976
 Nummer (number) : 1

3.9 Living spaces and attestation

Calculating living spaces

The living space calculation is influenced as follows:

Room definition

- Living space percentage
- Max. room height
- Wall covering thickness (set value or specified value base).
- Deduction areas and additional areas of wall covering. See [Living space with additional areas and deduction areas of wall finish](#)

Construction parts

- Room-limiting construction parts
- Storey slabs, level slabs, hollow ceiling, stair and roof

Settings

- Settings using quantities manager

- Factors for limit heights

- Minimum niche depth (Germany WoFIV 0.13)
- Limit heights

New feature for EliteCAD AR13

The room height is no longer influenced by height definitions or zero roofs for the living space calculation.

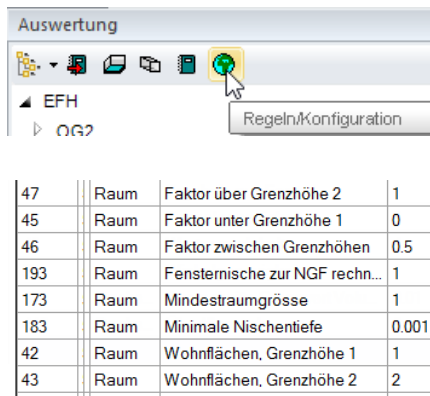

ID	Typ	Beschreibung	Wert
47	Raum	Faktor über Grenzhöhe 2	1
45	Raum	Faktor unter Grenzhöhe 1	0
46	Raum	Faktor zwischen Grenzhöhen	0.5
193	Raum	Fensterische zur NGF rechn...	1
173	Raum	Mindestraumgrösse	1
183	Raum	Minimale Nischentiefe	0.001
42	Raum	Wohnflächen, Grenzhöhe 1	1
43	Raum	Wohnflächen, Grenzhöhe 2	2

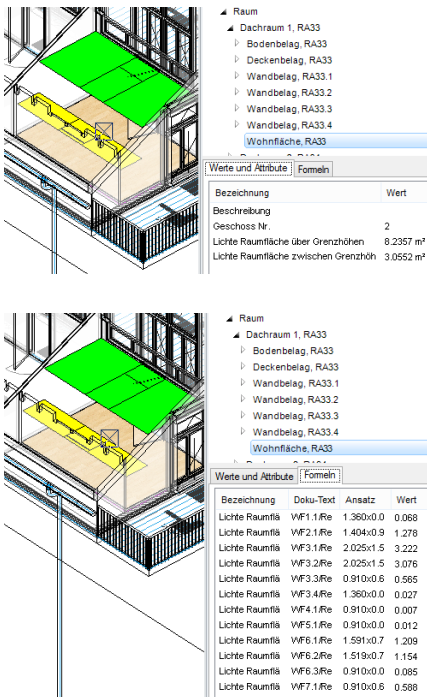

Living space in quantities manager

Living spaces are displayed using different colours in the living space object type.

In the index of values and attributes, the calculation results are listed.

In the formulae index, the part areas are listed with the calculation key.

Graphical living space verification

Settings

Menu Settings > Options

Work parameters > Plane(s) verification

Section living space verification

Text parameter(s)

Pens for surface contour and for deductions

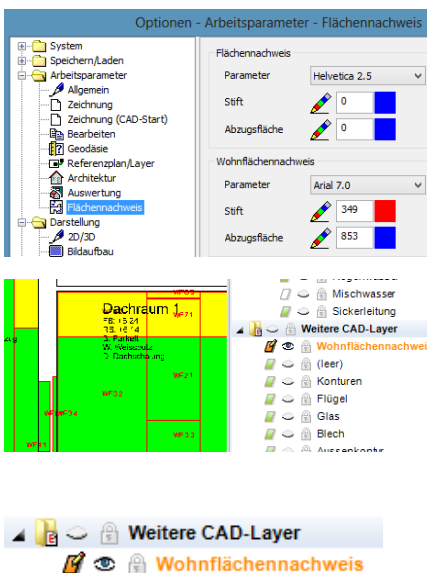

The contours are created in the plane(s) verification layer.

The display of part areas and their docu-texts are carried out in accordance with the settings.

The part areas are broken down by limit heights and marked with cross-hatching using the same colours as in the display via quantities manager.

The room-dividing construction parts are created using Pen 5.

Living space verification list

1.2.91 Living space verification of areas

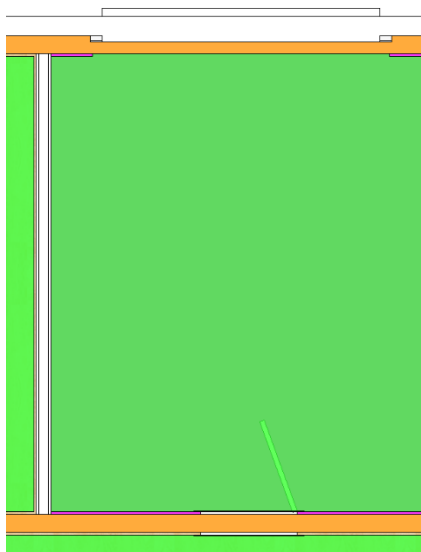
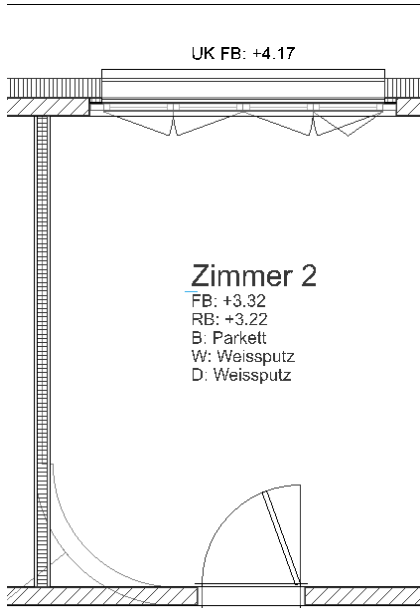

Living space calculation with different wall covering thicknesses.

Setting dependent on wall material (base)

Example in the course model Storey 1st Upper Level, dividing wall between Room 2 and Room 1 is a plaster partition wall.

If in the room parameters for wall covering thickness the button to the right next to the input field is locked, then the plaster thickness or covering thickness proceeds in accordance with the set values, [Index of wall covering thickness](#), so long as the wall material and the covering thickness are recorded in the list.

On the other walls, the covering thickness of the room definition (illustration) is then calculated.

For the example, in the [Index of wall covering thickness](#), thickness 0 is entered for plaster. For that reason, the control layer living space attaches living space with deduction for plaster 100% to the dividing wall. (Select solid display). On the other walls, a different wall covering thickness is calculated.

4. Room finishes

The settings for the room definition are described in Chapter 3.

4.1 Room finishes, general

Materials

The names of materials for floor finishes and the assignment to the layer groups covering finish and covering finish sublayer is carried out using the overarching term for synonyms and the layer types floor on facing or subconstruction. See [diagram: Management using materials](#)

For wall and slab finishes, in BIM2COST only the synonyms are effective.

Floor finishes

Contours of floor finishes

The floor finishes are calculated using the room contour. The main contour of the floor finish cannot be changed. The individual layers of the floor finish can be extended in EliteCAD AR13. For this, the individual layer can also be extended via the main contour (by contrast with normal multi-layer construction parts).

Room definitions without floor finish

For the area type air space, no floor finish is calculated. If a normal room definition is located above a slab, then no floor covering is calculated. Floor finishes are only calculated via level and storey floors.

Floor finish on stairs

A floor finish is calculated on stairs.

Multi-layered floor finishes

Floor covering finish

The layer group floor covering finish is set via the facing layer type.

Floor finish sublayer

The layer group floor finish sublayer is set via the sub-construction layer type.

Additional and deduction planes

The topmost covering layer can be deducted to a part area or replaced.

Via the topmost covering layer, an additional layer can be created.

Lists

The layers are listed in groups if the individual layers have the same dimensions.

The floor finish sublayers are listed with the Swiss specialist term “Unterlagsboden” (subfloor). A subfloor contains possible insulation layers, together with the screed.

Flat roof coverings in BIM2COST

The flat roof coverings for cost estimating in BIM2COST are determined using the floor covering, area type external room

Wall finishes

Determining wall finishes

In EliteCAD, the wall finishes are not drawn, but calculated from the room-limiting construction parts.

Wall finishes are calculated for:

- Walls, room-dividing and non room-dividing
- Slab faces
- Facings on girders

On wall openings, the deduction audit establishes whether the opening can be deducted accordingly from the trade Plaster.

Upper and lower limit of wall finishes

Wall finishes are limited by:

- Storey and level floor
- CAD floor of type roof
- CAD floor of type stair landing
- CAD floor of type hollow ceiling
- Stairs adjoining wall
- Roofs
- Max. room height in room definition
- Height definitions

Base and object types

Wall finishes are evaluated separately by base material and accordingly listed in different object types.

Model: Structure EFH, Basement Section 3

Wall covering finish RA11.2

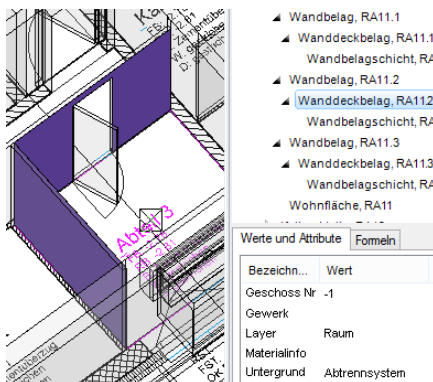

On base separating system

In the wall finishes list, the finishes for each base are listed separately.

Layers for wall finishes

In EliteCAD only one layer can be entered.
In BIM2COST multiple layers can be entered.

Wall covering finish

In EliteCAD, the layer becomes the wall covering finish
In BIM2COST, the imported layer becomes the wall covering finish.

Wall finish sublayer

In BIM2COST wall finish sublayers can additionally be entered.

Additional and deduction planes

The wall finish can be deducted to a part area or replaced.
Via the wall finish, an additional layer can be created.

Allocation rules in BIM2COST general

The allocation rules to cost components in BIM2COST take account of the wall finish bases.

Examples:

On bases such as glass, lath partition etc. there is no allocation to cost components.

On bases such as plaster and plasterboard, only the covering finish is allocated to cost components.

On bases like concrete, there is an additional allocation to the cost component base plaster (logical total structure).

Allocation rules in BIM2COST materials

In BIM2COST there are allocation rules to cost components in place both for the ceiling finish of the room definition and also for drawn building components.

Example:

Room definition with wall finish timber formwork and wall facing timber formwork.

Optimization can be undertaken as follows:

Option 1: Room definition without material description or a material name which is not allocated to the overarching term timber facing.

Option 2: Analogous procedure with material name for wall facing.

Option 3: Modify allocation rules.

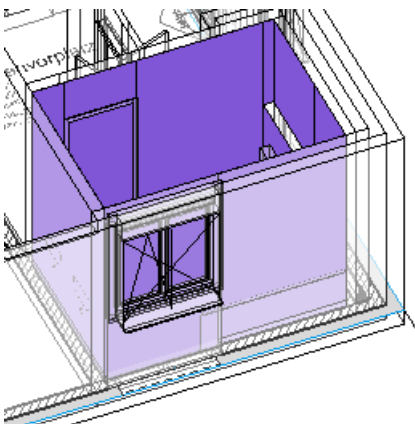
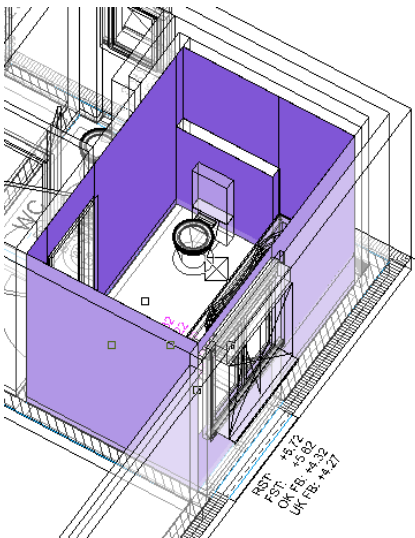

Calculation, deduction audit and quantities manager

In the top illustration (Switzerland), the openings are deducted, in the lower illustration (Germany) they are not. The deduction limits are defined differently for the countries using Options (Chapter 7.3).

Werte und Attribute		Formeln	
Bezeichnung		Wert	
Alle Belagschichten, Anzahl		1	
Aussen		Nein	
Dicke		0.02	
Fläche		23.2254	
Geschoss Nr.		1	
Layer		Raum	
Material		Platten	
Materialgruppe		Keramikplatten	
Materialinfo		Keramikplatten	
Untergrundmaterial		Backstein	

Material as per room definition (only object type wall finish + wall finish layer)

Material group describes the overarching term as per the synonyms setting (only object type wall finish + wall finish layer).

Material information contains all overarching terms for materials which the object type contains (object types wall covering finish and wall finish sublayer can comprise multiple layers in BIM2COST).

Werte und Attribute		Formeln	
Bezeich...	Gewerk	Ansatz	Wert
RA13.1		0.125x1.3	0.163
RA13.1		2.855x2.7	7.709
RA13.2		0.88x2.12	-1.8656
RA13.1		2.05x2.7	5.535
RA13.1		2.98x2.7	8.046
RA13.2		1.4x1.48	-2.072
RA13.1		0.9x2.7	2.43
RA13.1		1.15x1.3	1.495
RA13.1		1.15x1.4	1.61
RA13.1		0.125x1.4	0.175

Detailed calculation in the index of formulae

Slab finishes

Determining slab finishes

In EliteCAD, the slab finishes are not drawn, but calculated from the room-limiting construction parts.

Slab finishes are calculated on the underside of

- Storey and level floors
- CAD floors of type roof
- CAD floors of type stair landing
- CAD floor of type hollow ceiling
- Stairs
- Roofs

If a maximum room height is defined in the room definition, the slab finish is calculated at this height.

If no component (in line with the above listing) is present either in the current storey or in the storey above, then no slab finish is calculated in EliteCAD.

Layers for slab finishes

In EliteCAD only one layer can be entered.

In BIM2COST multiple layers can be entered.

Slab covering finish

In EliteCAD, the layer becomes the slab covering finish

In BIM2COST, the imported layer becomes the slab covering finish.

Slab finish sublayer

In BIM2COST slab finish sublayers can additionally be entered.

Additional and deduction planes

The slab finish can be deducted to a part area or replaced.

Via the slab finish, an additional layer can be created.

Cost allocation rules BIM2COST for materials

By analogy with wall finish

4.2 Multi-layered floor finishes

Create floor finish

Model: Structure: EFH, GF Residential

Room definition

Section floor.

The material description takes priority for the topmost layer.

Here granite

Right button, parameter(s) for floor construction

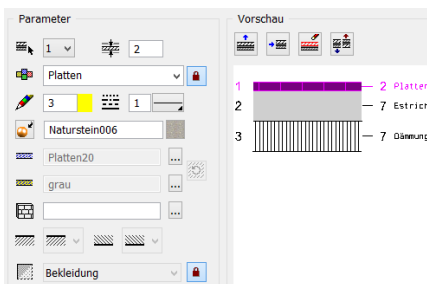
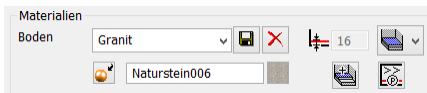

The topmost layer is defined with the material slab.

This material is overridden by the material in the room definition (meaning that there is no need to record each material as a parameter for the imaging depth).

Via the lock, the material is linked with the settings for the layer types (quantities manager).

Here the slab material is defined as a facing layer type.

The other layer types are defined by the link as a sub-construction layer type.

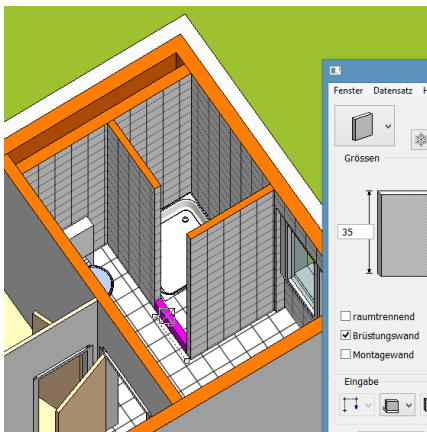

Modifying layer contours

Model: Structure: EFH, GF Shower

The pedestal is marked as a non room-dividing wall.

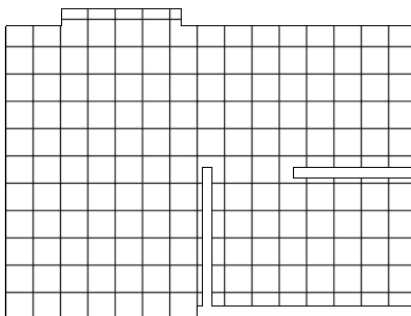

Note: In the evaluation model, the floor finish was already modified. The procedure for the unmodified floor finish is described below.

Construct room

Image before changing layer contours

For the pedestal, the floor finish is continuous with all layers.

Under the shower, the floor finish is continuous.

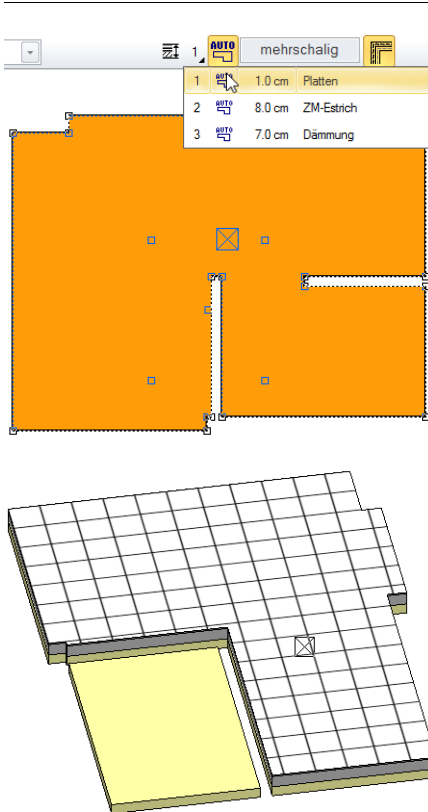

Edit floor finish

Each individual layer must be edited.
For the procedure, see the Manual section on rooms.

For the pedestal, all layers were removed.
Below the shower, only the insulation layer has been left untouched.

Floor finishes and BIM2COST

Normal floor finishes

Allocation to cost components floor finishes room.

- G 2.1.1 Screeds in composite (Rooms in basement)
- G 2.2.1 Floating screeds (GF)
- G 2.3.x Floor covering finish as per material

Flat roof coverings

Allocation to cost components for flat roof covering

- Requirement: Area type external room
- Model: Structure EFH, Upper Storey 2 Terrace
- F 1.2.1 Upstands and downstands
- F 1.2.5 Seals with insulation
- F 1.5.x External floor coverings by material
- Here
- F 1.5.2 Protective layer flat roof capable of being walked on

4.3 Additional and deduction planes

Additional and deduction planes for floor finishes

Additional finish for floor finishes

Model: Structure: EFH, GF Residential

Button definition of an additional floor construction

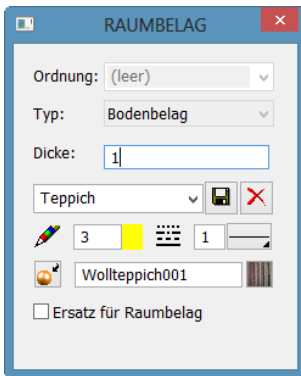

- Thickness
- Material
- Outline pen
- Texture
- Option replace for wall finish not enabled

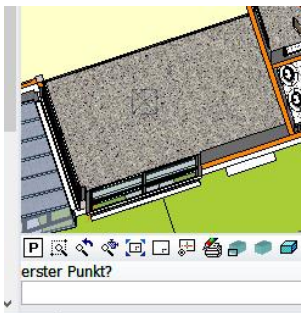

Draw outline (masks must be open)

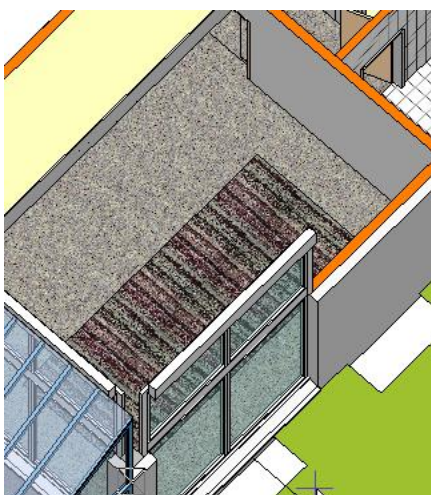

In the model, this additional floor finish is already inserted.

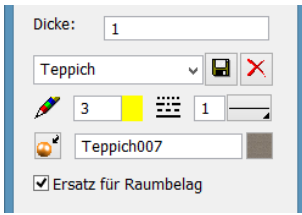

Replacement finish for floor finishes

Model: Structure: EFH, GF Area in front of stairs

Option replace for room finish enabled

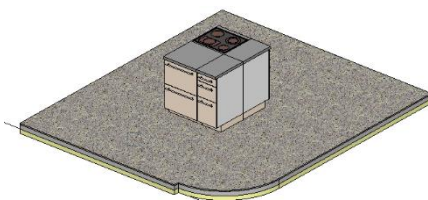

Remove floor covering finish

With normal change of layer contours. See [Modifying layer contours](#)

Alternatively, the floor covering finish can also be removed via the room definition.

Model EFG, GF Kitchen.

Construct room definition and kitchen furniture

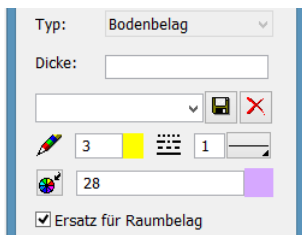

Without materials

Option replace for room finish enabled

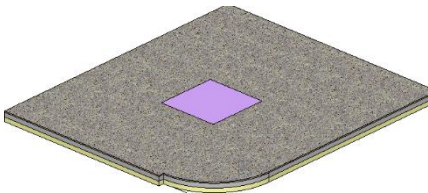

By contrast with the method for modifying layer contours, the surface is replaced with a 3D surface with the property deduction area.

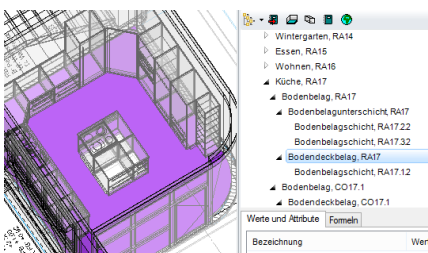

In quantities manager, select floor covering finish

The floor covering finish is cut out



With the deduction area method, an object type floor covering finish CO is created.

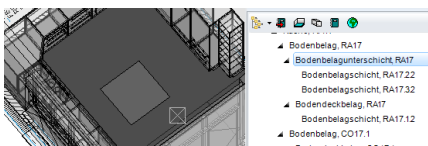

The subfloor (object type floor finish sublayer) is not cut out.

Additional and deduction planes for wall finishes

Additional finish for wall finishes

Model: Structure EFH, Shower

Button definition of an additional wall construction

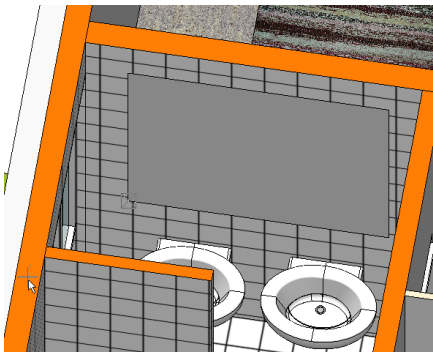
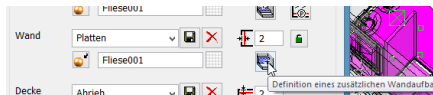

Thickness

Material

Outline pen

Texture

Option replace for room finish disabled

In the model, this additional area is already inserted.

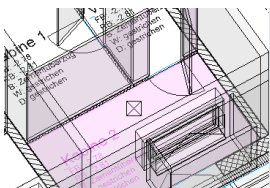
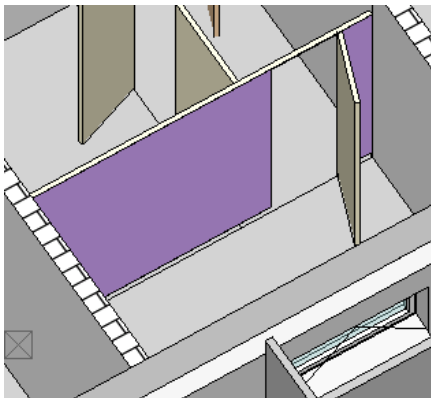
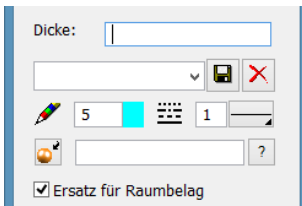

- Leistenbelagschicht, RW1.12
- Wandbelag, RA7.1
- Wanddeckbelag, RA7.11
- Wandbelagschicht, RA7.11
- Wandbelag, RA7.2
- Wanddeckbelag, RA7.2
- Wandbelagschicht, RA7.12
- Wandbelag, RA7.3
- Wanddeckbelag, RA7.3
- Wandbelagschicht, RA7.13
- Wandbelag, CO7.1
- Wanddeckbelag, CO7.112
- Wandbelag, RA7

Deduction planes for wall finishes

Model: Structure EFH, Basement Cubicle

No thickness
No materials

Option replace for room finish enabled

The area is drawn over the cubicle dividing wall
Depending on the setting of the deduction audit plaster, the doors are cut out.

In the model, this deduction area is already inserted.

For the first wall covering finish (on this wall), nothing is displayed.

For this, a wall covering finish CO is created for the deduction area.

In the wall covering list, now only the deduction area remains listed on the base cubicle dividing wall, while the material “painted” is no longer showing.

Wanddeckbelag

0.0 cm (Total 0 cm)

Untergrund: Kabinentrennwand

UG-07	CO7.1	Kabine 2	FF
	Nr.	Berechnung	Fläche
	CO7.1	2.125x1.940+1.940x0.250+0.600x0.010	4.61 m ²
	Total		4.61 m²
	Material		Fläche
	0.0 cm		4.61 m ²

Deduction planes for BIM2COST

On this wall, in BIM2COST no allocation to a cost component is made even without any deduction plane (base cubicle dividing wall).

The deduction planes are taken into account in BIM2COST.

Replacement areas for wall finishes

Analogous procedure, but with option replace for room finish enabled.

Additional and deduction planes for ceiling finishes

The procedure is the same as for wall finishes

Living space with additional areas and deduction areas of wall finish

If an additional area is inserted for a wall finish, the living space is reduced by the thickness of the additional finish

Model: Structure: EFH, GF Shower

Additional wall finish (mirror) reduces living space



If a deduction area is inserted for a wall finish, the living space is increased at this spot (not illustrated)

4.4 Room finishes in special rooms and situations

Room finishes for special construction parts

Room finishes for girders

Model: Structure Timber construction, Basement Garage

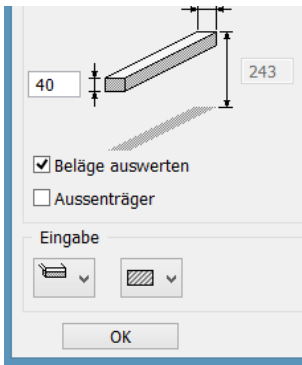

If the evaluate finishes option is set, then ceiling finishes are calculated to the side of the girder

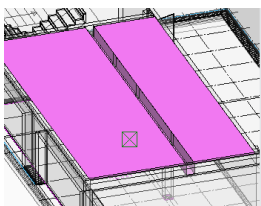

- ↳ Bodenbelag, RA44
- ↳ Bodenbelagunterschicht, RA44
- ↳ Bodenbelagschicht, RA44.1.2
- ↳ Deckenbelag, RA44
- ↳ Deckendeckbelag, RA44.1
- ↳ Deckenbelagschicht, RA44.1.2
- ↳ Deckendeckbelag, RA44.2
- ↳ Deckenbelagschicht, RA44.1.3
- ↳ Wandbelag, RA44.1
- ↳ Wanddeckbelag, RA44.1
- ↳ Wandbelagschicht, RA44.1.1
- ↳ Wandbelag, RA44.2
- ↳ Wanddeckbelag, RA44.2
- ↳ Wandbelagschicht, RA44.1.2

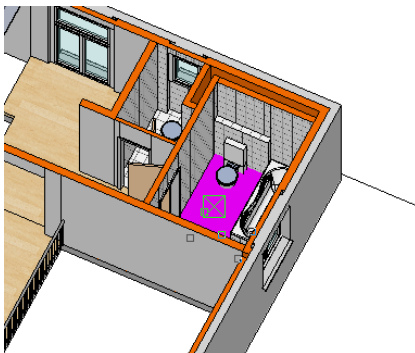

Wall finish for parapet with brick cladding

Model: Structure EFH, Upper Storey 1 Bathroom

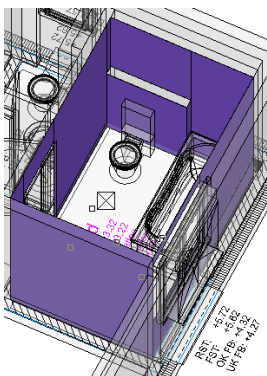

- ↳ Wanddeckbelag, RA11.2
- ↳ Wanddeckbelag, RA12.1
- ↳ Wanddeckbelag, RA12.2
- ↳ Wanddeckbelag, RA14.1
- ↳ Wanddeckbelag, RA14.2
- ↳ Wanddeckbelag, RA17.1
- ↳ Wanddeckbelag, RA17.2
- ↳ Wanddeckbelag, RA18.1
- ↳ Wanddeckbelag, RA18.2
- ↳ Wanddeckbelag, RA19.1
- ↳ Wanddeckbelag, RA19.2
- ↳ Wanddeckbelag, RA13
- ↳ Wanddeckbelag, RA15
- ↳ Wanddeckbelag, RA16
- ↳ Wandkonstruktion
- ↳ Wandschicht
- ↳ OO2
- ↳ ohne Baukörper
- ↳ ohne Geschoss

The wall finish is also calculated on non room-dividing walls (brick cladding for WC)

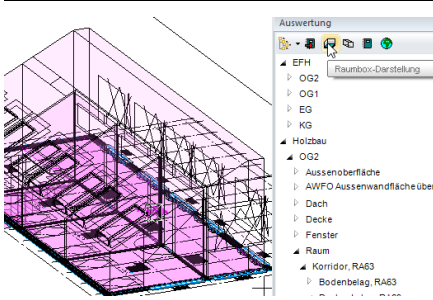

The room box display indicates that the net room volume is also reduced.

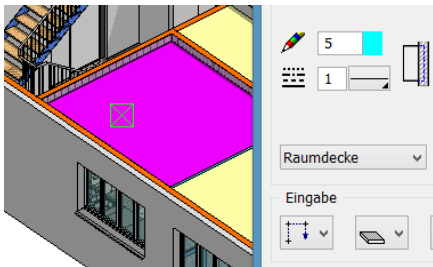

Room finishes for hollow ceilings

New feature for EliteCAD AR13
Model: Structure EFH, GF Kitchen

Beneath the storey ceiling in the kitchen room is a CAD floor of type **hollow ceiling** (suspended ceiling).
The upper layer was set transparently using the 3D functions.

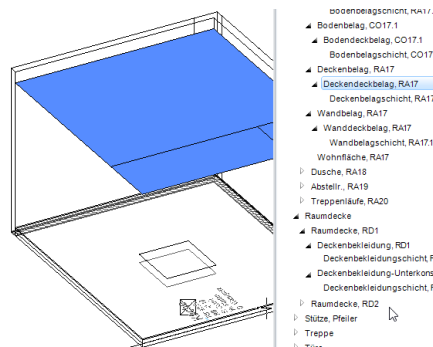

To illustrate: Construction of room definition and wall

The ceiling covering finish was calculated on the underside of the hollow ceiling.

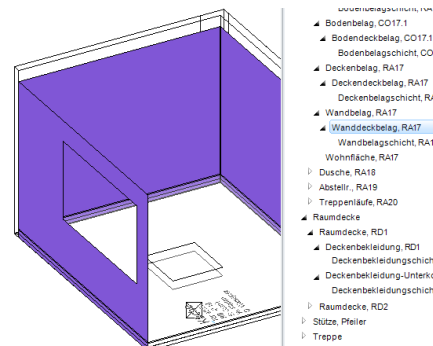

The wall covering finish is limited in height by the hollow ceiling.

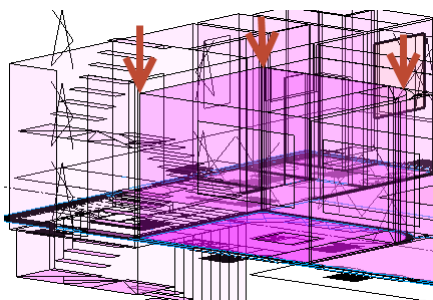

Room box diagram:
The net room volume is reduced by the hollow ceiling

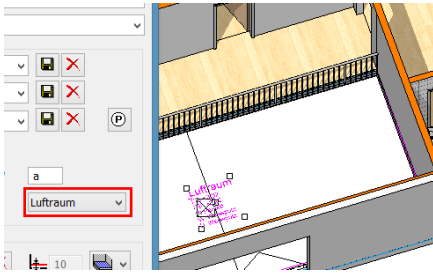

Room finishes for special rooms

Room finishes for air spaces

Model: Structure EFH, Upper Storey 1 Air space

For multi-storey rooms, the rooms located in the upper storeys must be defined as air spaces.

If this is done, no floor area is calculated for these rooms.

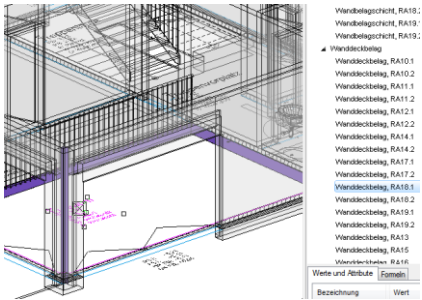

Wall finish for air spaces

The wall finish in this air space is divided between two object types, viz.:

1st object type with wall finish on slab faces

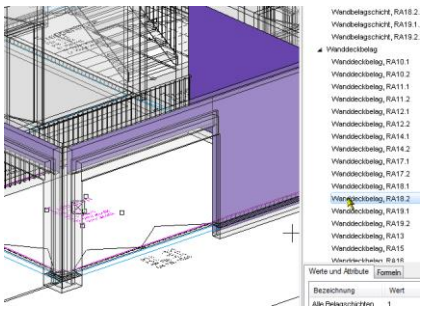

2nd object type with wall finish over the slab faces

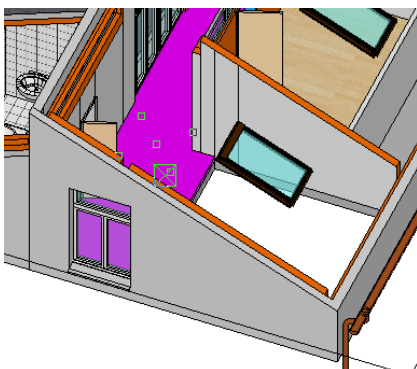
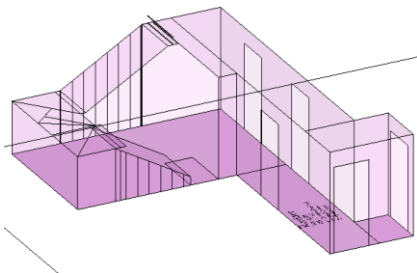
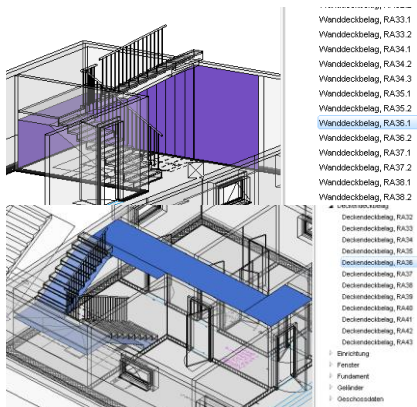
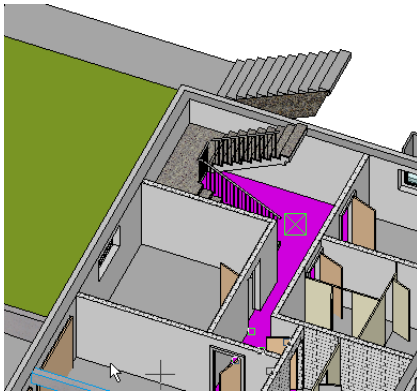

Room finishes for stairs

Rooms with stairs in the lowest storey

Model: Structure EFH

In the lowest storey, a room definition of the type “normal room” can be selected. This room may also lead into adjoining corridors.

Select wall finish in quantities manager.

Stairs adjoining a wall limit the wall finish beneath the stair.

The ceiling finish in this room is on the underside of stairs and ceilings.

In the CAD, construct the room definition and switch to room box display.

The room is height-limited for the stairs both for the calculation of volume and also for the living space calculation.

Rooms in the upper storeys

Illustrations with hidden layers roof and roof truss.

The room definition must be divided up.

For the 1st room definition over the storey floor, the normal room type is selected

(do not select stairwell type! See exceptional instance [Stairwell](#) Chapter 3.1).

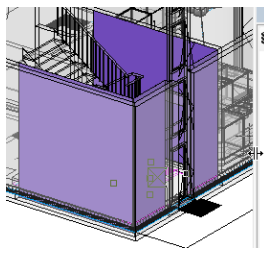
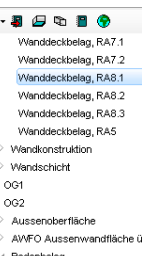
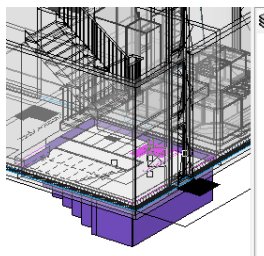
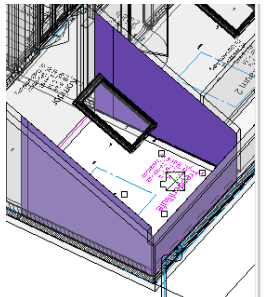
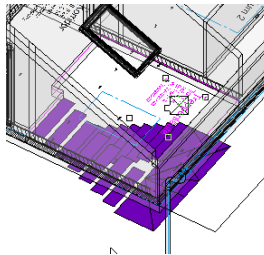
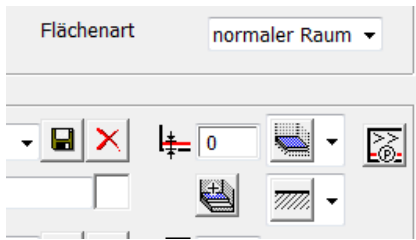
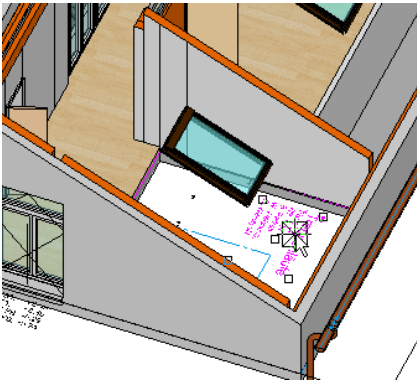

The 2nd room definition above the staircase is separated by a room division.

Note:

Under standards DIN 277, ÖNORM B1800 and SIA 416, stairs are always calculated in the upper storey. For that reason, a room definition must be set here with the entries shown below.

Select room definition in the CAD.

- normal room

- Floor thickness 0

This means no 3D floor is created. The floor area of the room is, however, calculated normally.

Select floor finish in quantities manager.

The floor finish is always calculated into the next lower storey.

If the stair does not adjoin a wall (as in this model in this storey), the wall finish is calculated from the lower edge of the storey ceiling.

In the ground floor, the finish is calculated to the stairs into the basement, since the stairs are connected to the wall (1st part wall finish).

Since the stairs to the upper storey do not adjoin the wall, the wall finish is calculated to storey height (2nd part wall finish).

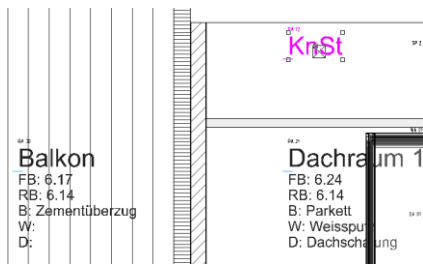

Flächenart

▲ Raum

- ▷ Dachraum 1, RA33
- ▷ Dachraum 2, RA34
- ▷ Terrasse, RA36
- ▷ Korridor, RA37
- ▷ Bad, RA38
- ▷ Balkon, RA42
- ▷ Treppenläufe, RA43
- ▷ Türe

Jamb wall spaces, shafts, construction area

In the CAD, select jamb wall in the topmost storey.

If a room is not to be counted as part of the net storey area (SIA 416), or net area (DIN 277 + ÖNORM B1800) and if no room finishes are to be calculated either, then no room definition must be set, or one with type construction area.

Rooms with area type construction area are not listed in quantities manager.

No room finishes are calculated.

5. Construction parts

5.1 General

Room-forming functions

Overview

- Walls (can be selected to separate rooms)
- Girder from wall function (can be selected to separate rooms)
- Column
- Chimney
- Glass elements (can be selected to separate rooms)
- Room separator

raumtrennend

Use of room-separating functions

- EliteCAD calculates polygons from the arrangement of the room-separating functions. If this is locked, a room definition can be inserted.
- EliteCAD calculates the perimeter contour from the arrangement of the room-separating functions, which is used to calculate the storey area. This perimeter contour must be closed.

Errors in the application

- Room-separating functions must not overlay one another.
Example:
If two walls are drawn over one another, then only one wall can be set as room-separating.
- Room separators may not be run along room-separating walls.
- Room separators must not cross one another.

Height-separating functions

Overview

Height separating on the underside and upper side

Rooms can be separated on the underside and upper side in height using the following functions:

- CAD floors with height reference level floor and storey floor
- CAD floors of type stair landing

Height-separating on the underside

- CAD floors of type hollow ceiling with height reference free slab
- Roof and height definition

5.2 CAD floors

Overview

Various construction parts are created using the floor function.

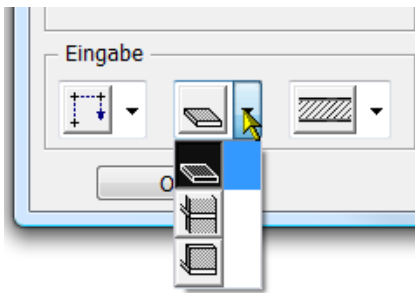
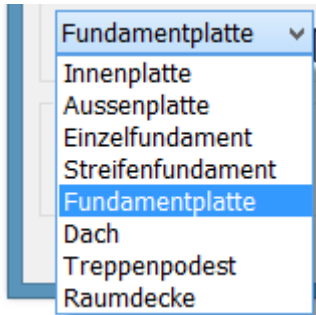

Internal foundation

External foundation (external foundation for balconies and pergolas)

Single foundation

Strip foundation

Foundation slab

Roof (for flat roofs above and below terrain)

Stair landing

Hollow ceiling (suspended ceiling)

Height reference

The height reference simultaneously defines whether the floor is height-limiting (room) or not:

- Free slab, not height-limiting.
- Storey floor, height-limiting
- Level floor, height-limiting

Special floor setting: Hollow ceiling

The hollow ceiling always defines the room on the underside of the hollow ceiling.

The hollow ceiling must be drawn as a free slab.

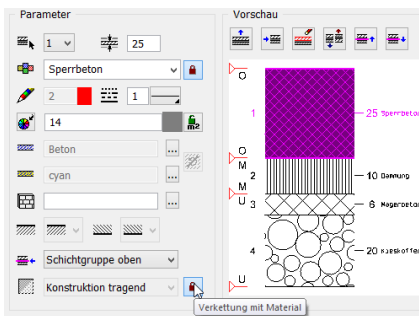
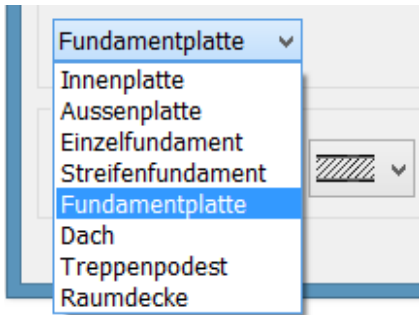
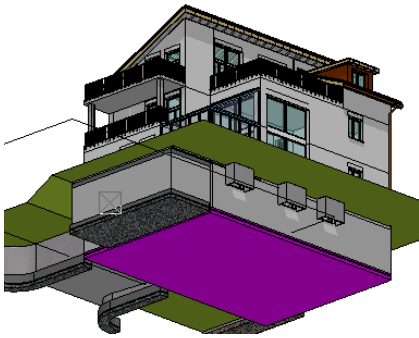

Foundations

Foundation slabs

In the CAD, select the floor slab as per the illustration.

Open the parameter mask

- Foundation slab

- Waterproofing concrete > load-bearing
- Insulation > Facing
- Lean concrete > Subconstruction
- Gravel layer > non load-bearing

- Concatenation with material: Load-bearing for waterproofing concrete material

Layer type	Object type
Load-bearing	Foundation construction
Non load-bearing	Foundation subfloor
Subconstruction	Socket concrete
Facing	Foundation insulation

Cost allocation rules in BIM2COST 13

- C 1.2.1 Seals
- C 1.2.2 Insulation
- C 1.4.1 Gravel pack
- C 1.4.4 Socket concrete
- C 1.5 Slab bearing

List for foundations

- 2.2.01 Foundations
- Breakdown by foundation types and layer types

Strip foundations

- Strip foundation
- Rest as above

Cost allocation rules in BIM2COST 13

C 1.3.2 Strip foundations

Single foundations

- Single foundation
- Rest as above

Cost allocation rules in BIM2COST 13

C 1.3.1 Single foundations

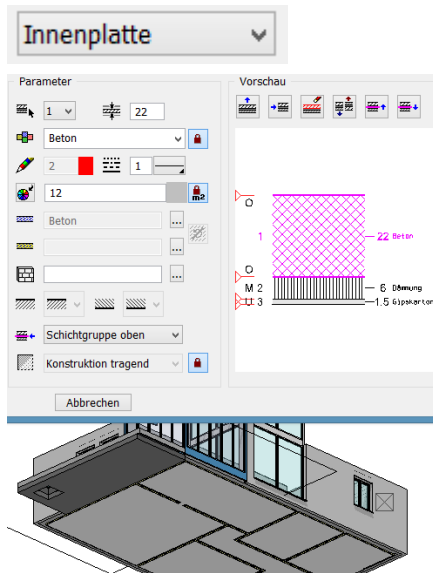

Ceilings

Concrete ceiling with cladding underneath

Model: Structure EFH, Floor GF

- Internal foundation

- Concrete > load-bearing
- Insulation > non load-bearing
- Plasterboard > Facing

Layer type	Object type
Load-bearing	Floor construction
Non load-bearing	Floor construction, non-bearing
Subconstruction	Floor subconstruction
Facing	Floor facing

Cost allocation rules in BIM2COST 13

- C 4.1.1 In-situ concrete ceilings or
- C 4.2.1 Stairs, if in stairs layer
- G 4.3.2 Panels (ceiling panelling)

Lists for internal ceilings

- 2.2.02 Concrete slabs
- 2.2.11 Various ceiling constructions and facings
- 2.2.91 All ceiling layers (without breakdown)

Ceiling with timber floor joists

Model: Structure Timber construction, Floor Upper Storey 1

- Internal foundation

- Dead floor > Subconstruction
- Beam insulation > load-bearing
- Batten > Subconstruction
- Gypsum fibre boards > Facing

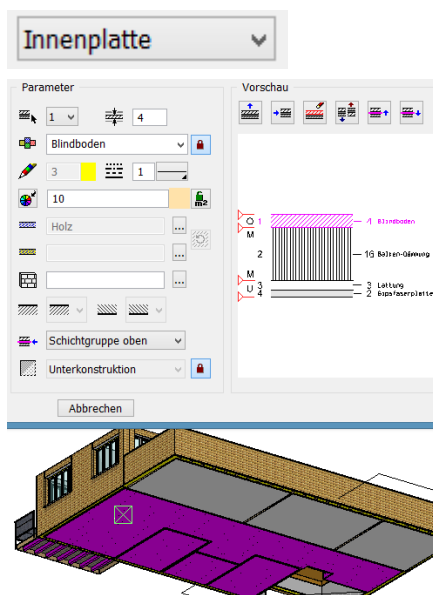

Cost allocation rules in BIM2COST 13

- C 4.1.5 Timber floors
- G 2.2.3 False floors
- G 4.2.2 Underconstructions (ceiling panelling)
- G 4.3.2 Panels (ceiling panelling)

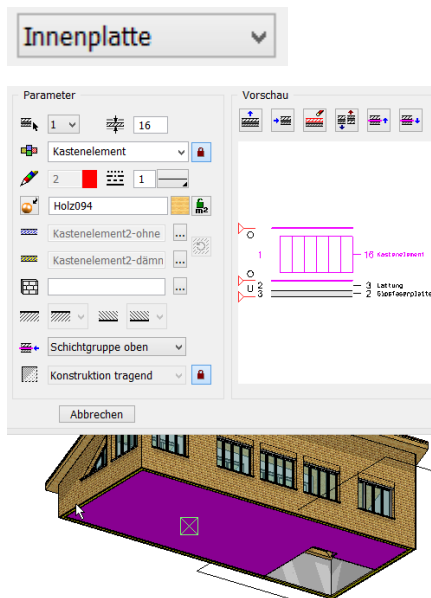

Ceilings timber panel construction

Model: Structure Timber construction, Floor Upper Storey 2

- Internal foundation

- Box element > load-bearing
- Batten > Subconstruction
- Gypsum fibre boards > Facing

Cost allocation rules in BIM2COST 13

- C 4.1.5 Timber floors
- G 4.2.2 Underconstructions (ceiling panelling)
- G 4.3.2 Panels (ceiling panelling)

Lists for timber ceilings

- 2.2.11 Various ceiling constructions and facings
- 2.2.91 All ceiling layers (without breakdown)

Balconies in concrete

Model: Structure EFH, Balcony Upper Storey 2

- External foundation

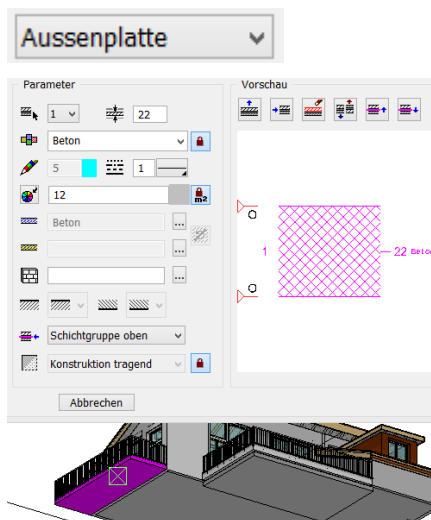

- Concrete > load-bearing

Cost allocation rules in BIM2COST 13

- C 4.3.1 In-situ concrete balconies
- F 1.4 Lightning protection

Lists for concrete balconies

- 2.2.02 Concrete slabs
- 2.2.11 Various slab constructions and facings)
- 2.2.91 All slab layers (without breakdown)

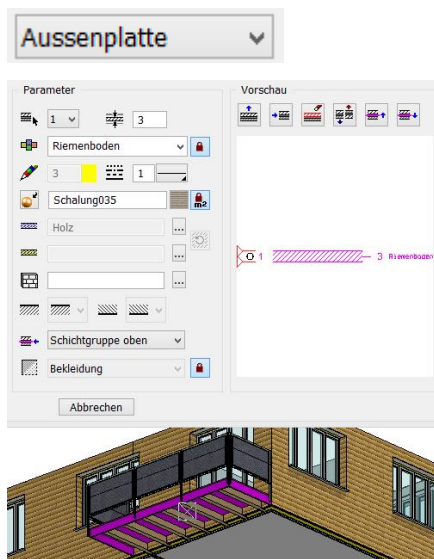

Balconies in timber

Model: Structure Timber construction, Balcony, Upper Storey 1

- External foundation

- Strip flooring > Facing

Cost allocation rules in BIM2COST 13

C 4.3.4 Timber balconies

F 1.4 Lightning protection

F 1.5 External floor finishes and ceiling finishes flat roof
(additional cost component)

F 1.5.6 Floor finishes in timber and timber materials

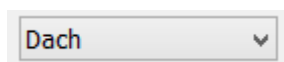

Roofs (from CAD floors)

(Roofs created using the floor function)

Distinguishing roof - external foundation

Under the cost component method applied in BIM2COST, slabs which end a room above against the external area are considered as a roof.

CAD slabs defined as a roof are listed in the roof list.

However, if CAD slabs are listed in the slabs list, then external foundation should be selected and amended in BIM2COST to roof.

Concrete roofs below terrain

- Model: Structure EFH, Floor GF above store
- Waterproofing concrete > load-bearing

Cost allocation rules in BIM2COST 13

C 4.4.1 In-situ concrete roofs

F 1.1.4 Seal without insulation (with option in soil)

F 1.4 Lightning protection

Lists for concrete roofs

2.2.03 Concrete roofs

2.3.91 All roof layers (without structure)

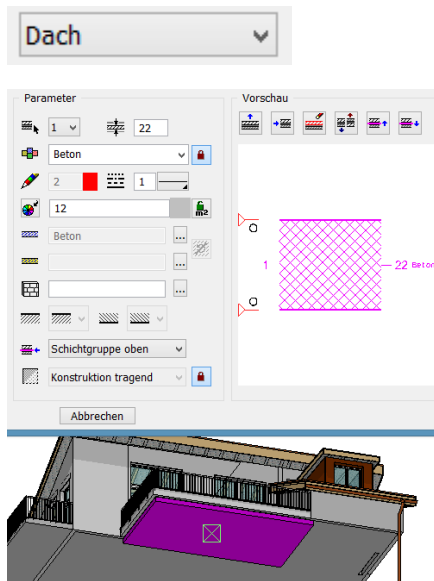

Concrete roof (flat room) above terrain

Model: Structure EFH, Floor Upper Storey 2 Flat Roof Terrace

- Roof

- Concrete > load-bearing

The roof skin (flat roof) is created with the room definition.

Cost allocation rules in BIM2COST 13

C 4.4.1 In-situ concrete roofs

F 1.4 Lightning protection

Lists for concrete roofs

2.2.03 Concrete roofs

2.3.91 All roof layers (without structure)

BIM2COST

Do not enable in-soil in BIM2COST.

Timber flat roof

Model: Structure Timber construction, Floor Upper Storey 1 Flat Roof Terrace

- Roof

- Dead floor > Subconstruction
- Beam insulation > load-bearing
- Batten > Subconstruction
- Gypsum fibre boards > Facing

The roof skin (flat roof) is created with the room definition.

Cost allocation rules in BIM2COST 13

C 4.4.5 Timber roofs

F 1.4 Lightning protection

G 4.2.2 Underconstructions (ceiling panelling)

G 4.3.2 Panels (ceiling panelling)

Lists for timber flat roofs

2.3.01 Roof planes and edges

2.3.91 All roof layers (without structure)

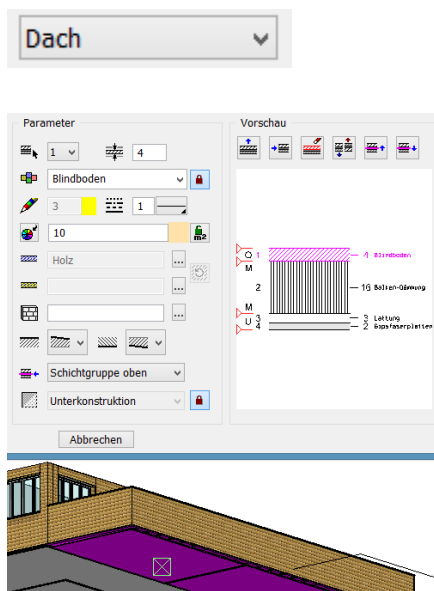

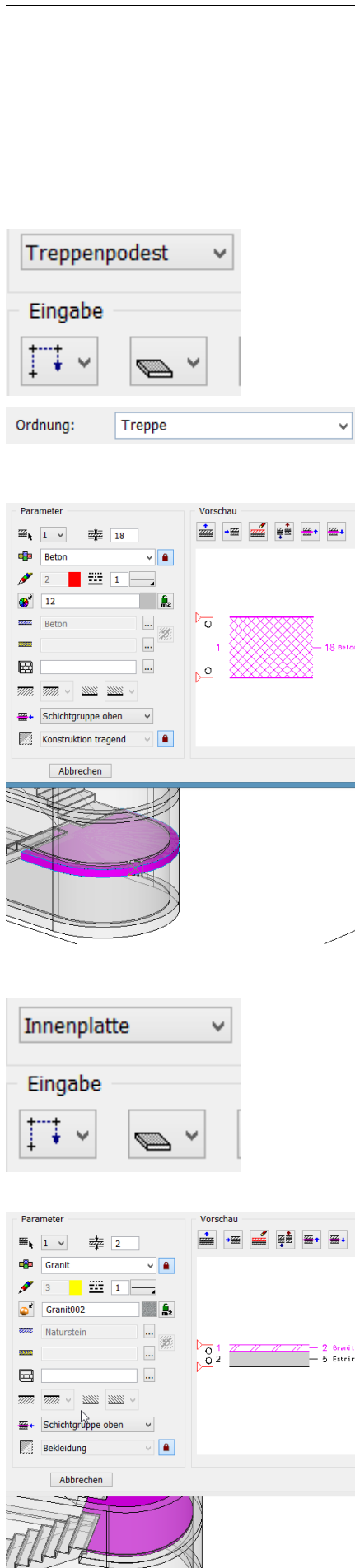

Stair landing

The type stair landing is used for landings create from CAD floors. The room volume calculation and the room finishes then behave in a similar manner as for normal stairs.

See also [Example of stair with landing](#) (Chapter 1.8).

Reading in the stair landing model

- Stair landing
- Free slab
- Rules (layer) stairs (for BIM2COST mandatory)
- Concrete > load-bearing

The floor finish is not created with the room definition, since two room definitions are not permitted to lie over one another in the same storey.

Cost allocation rules in BIM2COST 13

C 4.2.1 In-situ concrete stairs

Floor finish on stair landing

The floor finish is created with the floor function, internal foundation.

This floor finish is only assigned in BIM2COST to the cost component floor finish.

- Free slab
- Granite > Facing
- Screed > Subconstruction

Cost allocation rules in BIM2COST 13

G 2.1.1 Screeds in composite (if no insulation is present)

G 2.2.1 Floating screeds (if insulation is present)

G 2.3.6 Floor finishes in natural stone (or other finishes)

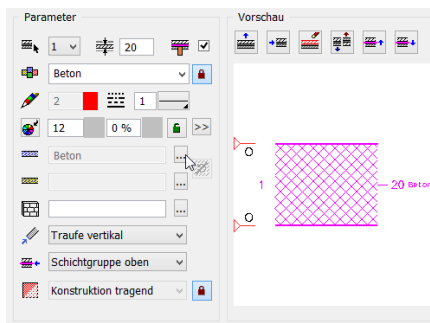

Concrete roofs (from CAD roofs)

(Roofs created using the roof function)
Without model template

- Concrete > load-bearing

Cost allocation rules in BIM2COST 13

C 4.4.1 In-situ concrete roofs

F 1.4 Lightning protection

Lists

2.2.03 Concrete roofs

2.3.91 All roof layers (without structure)

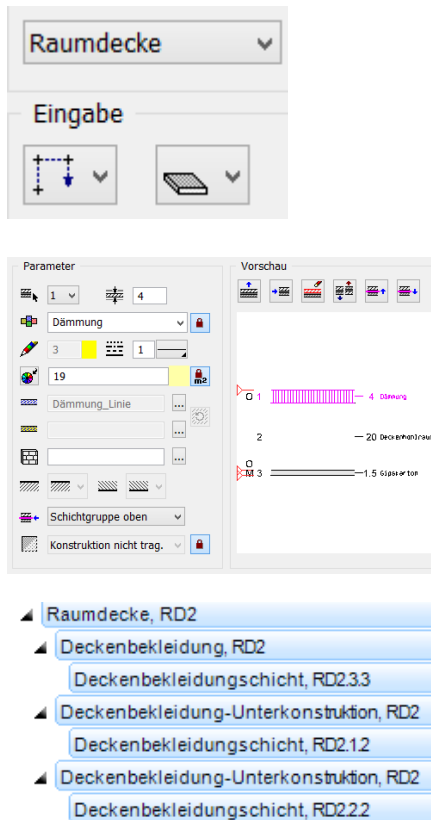

Hollow ceiling

The type hollow ceiling is used for slab facings with or without subconstructions and for suspended ceilings.

Examples: Insulation on the underside of cellar slabs, Slab facings in plasterboard, metal panels, etc.

The room volume in accordance with DIN 277, ÖNORM B1800 and SIA 416 is limited at the top by the lower edge of the hollow ceiling.

For the living space calculation (WoFIV), the lower edge of the hollow ceiling limits the room height.

Model: Structure EFH, Slab above dining area

- Free slab

- Insulation > non load-bearing *)
- Ceiling hollow chamber > Subconstruction
- Plasterboard > Facing

*) Layer types load-bearing and non load-bearing are evaluated like the layer type subconstruction for the hollow ceiling, as object type ceiling facing subconstruction.

Hollow ceiling	Object type
Load-bearing	Slab facing subconstruction
Non load-bearing	Slab facing subconstruction
Subconstruction	Slab facing subconstruction
Facing	Slab facing

Cost allocation rules in BIM2COST 13

G 4.2.2 Subconstruction

G 4.3.2 Tiles (or other slab facings, such as timber, etc.)

Lists for hollow ceilings

G 2.2.21 Special slab facings

2.2.91 All slab layers (without breakdown)

IFC

In order for slab facings to be imported from another CAD as a hollow ceiling, in the export CAD these construction parts must be exported as a finish or covering with the type ceiling.

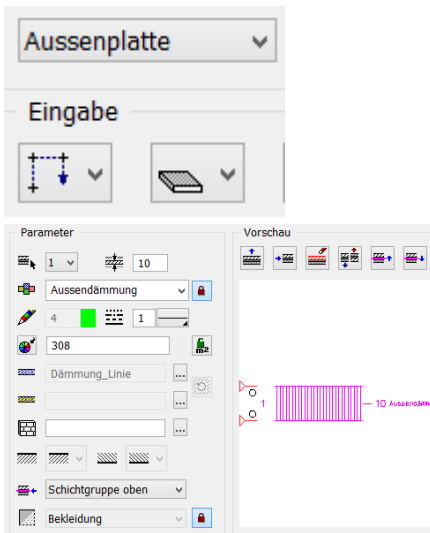

External ceiling soffits

The external ceiling soffits should not be created together with the storey ceilings.

Soffit external insulation

- External foundation

- Free slab

- External insulation > Facing

Cost allocation rules in BIM2COST 13

E 2.5.3 External thermal insulation soffit

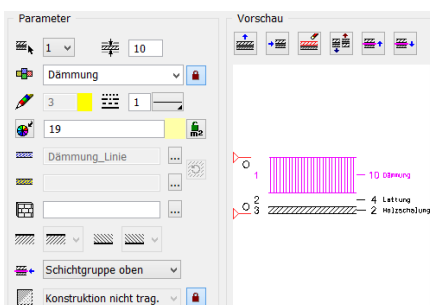

Soffit timber panelling

- External foundation
- Free slab

- Insulation > non load-bearing
- Battens > Subconstruction
- Roof boarding > Facing

Cost allocation rules in BIM2COST 13

E 2.5.1 Timber and timber materials (soffit)
 E 2.5.4 Coating (soffit)
 E 2.5.5 Insulation for back-ventilated facings

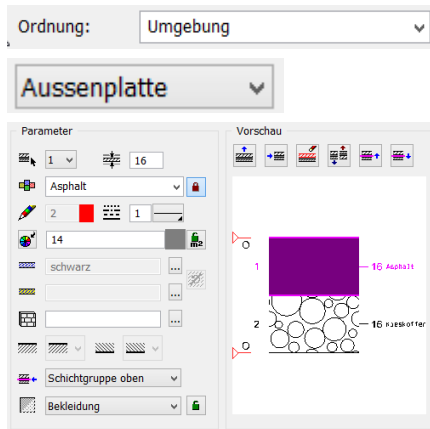

Floor function floor surrounding areas

The floor function can be used to evaluate surrounding areas.

Model: Structure Timber Construction, Front Yard

- Order (layer) surrounds
- External foundation

- Asphalt > Lock open, facing
- Gravel layer > Subconstruction

Cost allocation rules in BIM2COST 13

- I 1.1.2 Landscaping and rough formation
- I 4.1 Foundation layer
- I 4.3.4 Rolled asphalt finishes

Model: Structure Timber Construction, Hard Surfacing to side

- I 1.1.2 Landscaping and rough formation
- I 4.1 Foundation layer
- I 4.3.1 Composite and shaped brick finishes

Model: Structure Timber Construction, Lawn Area

- I 1.1.2 Landscaping and rough formation
- I 3.1 Vegetation layer
- I 3.2 Lawn

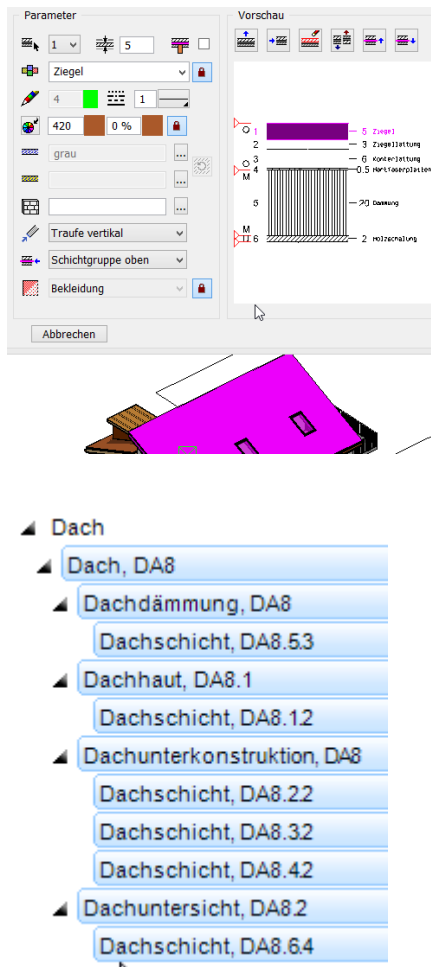

5.3 Sloping roofs

Rafter structure visible

Model: Structure EFH, main roof

- Roof tiles > Facing
- Tile laths > Subconstruction
- Counterbattens > Subconstruction
- Hardboard > Subconstruction
- Insulation > non load-bearing
- Roof boarding > Facing

Roof	Object type
Load-bearing	Roof construction
Non load-bearing	Roof insulation
Subconstruction	Roof subconstruction
Facing	Roof skin and soffit

The insulation should always be defined as non load-bearing
 The upper facing is evaluated as object type roof skin.

The lower facing is evaluated as object type roof soffit.

Cost allocation rules in BIM2COST 13

Note:

Since under eBKP-H the cost component roof construction (supporting structure) is calculated from the roof area, on the CAD roof the reference to the material of the supporting structure is missing.

But since the supporting structure is mainly in timber (rafter structure), in BIM2COST there is an allocation to the supporting structure in timber. This can be modified manually.

C 4.4.5 Timber roofs

- F 1.3.2 Coverings in tiles
- F 1.3.5 Location, eaves, ridge
- F 1.3.6 Insulation of pitched roof
- F 1.3.91 Vapour barriers (not drawn in the model)
- F 1.3.92 Underlay
- F 1.3.94 Laths
- F 1.4 Lightning protection

G 4.3.3 Timber and timber materials (ceiling facing)

Lists

- 2.3.01 Roof planes and edges
- 2.3.91 All roof layers (without structure)
- 2.4.01 Construction timber

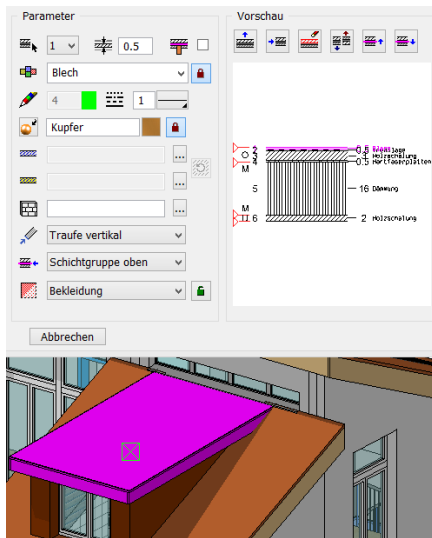

Rafter structure between insulation

Model: Structure EFH, Roof over roof construction

Note: The roof construction was created with the normal wall and roof functions.

- Copper > Facing
- Separating layer > Subconstruction
- Roof boarding > Lock open, subconstruction
- Insulation > non load-bearing
- Roof boarding > Facing

Cost allocation rules in BIM2COST 13

C 4.4.5 Timber roofs

- F 1.3.2 Coverings in sheet metal
- F 1.3.5 Location, eaves, ridge
- F 1.3.6 Insulation of pitched roof
- F 1.3.91 Vapour barriers
- F 1.3.92 Underlay
- F 1.3.93 Roof boarding sub-construction
- F 1.3.94 Laths
- F 1.4 Lightning protection
- G 4.3.3 Timber and timber materials (ceiling facing)

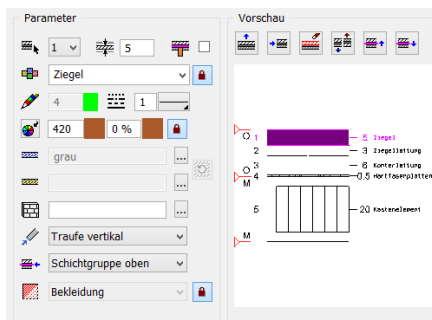

Roof timber element construction

Model: Structure Timber Construction

- Roof tiles > Facing
- Tile laths > Subconstruction
- Counterbattens > Subconstruction
- Hardboard > Subconstruction
- Box element > load-bearing

Cost allocation rules in BIM2COST 13

C 4.4.5 Timber roofs



- F 1.3.2 Coverings in tiles
- F 1.3.5 Location, eaves, ridge
- F 1.3.92 Underlay
- F 1.3.93 Roof boarding sub-construction
- F 1.3.94 Laths
- F 1.4 Lightning protection



Typ:  Pultdach 1Winkel

Material: Glas

Ordnung: Dach

Parameter

 5  7 

 827  70 % 

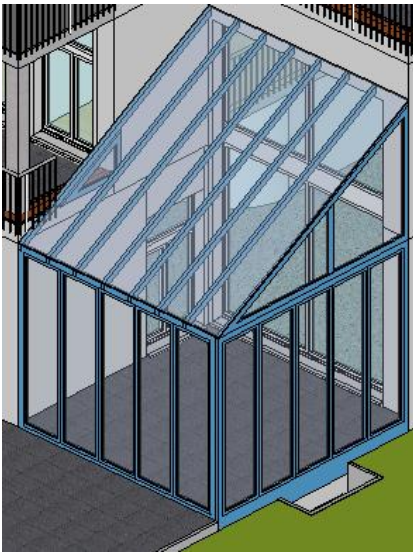

Glass roof created with roof functions

A glass roof is created using the normal roof functions.

Settings:

- Roof thickness: Glass thickness
- Material: Glass
(in the roof list, the glass roof is thus listed separately).
- 3D colour and transparency.
- Alternatively, instead of the 3D colour and transparency a transparent texture (e.g. glass) can be used.

The profiles are created using the roof truss functions. These are listed with an indication of the material in the construction timber list.

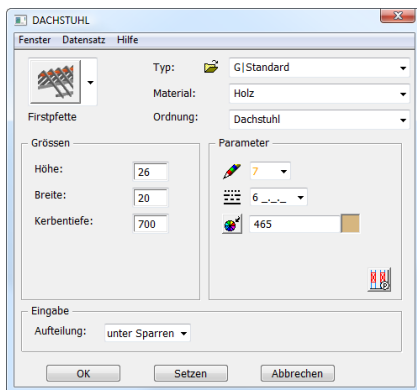

5.4 Truss

The truss is listed in the timber lists, sorted by material. The functions beams and posts can also be used in storeys without a roof. These are similarly evaluated.

BIM2COST

The truss has no importance up to cost component stage 4 element type group.

In order for it to be taken into account at stage 5 element type as a cost component, the material must be defined (e.g. glued timber). With different layers, further differentiation can be performed.

Columns/posts

If the cost component columns is to be evaluated in BIM2COST, then this must be created using the columns function (not with posts in the roof truss function).

 Montagewand

5.5 Walls

Internal/External walls

For the cost calculation using the element methods eBKP-H and DIN276, walls must be differentiated as internal or external. Required in BIM2COST.

External walls: EN 15221-6: EXTERNAL CONSTRUCTION SURFACE AREA AKF (SWITZERLAND)

Detailed breakdown of internal walls

The breakdown in accordance with standards ÖNORM B1800 2011 and EN 15221-6 2011 Area measurement in Facility Management is already installed in EliteCAD AR13 to create the internal walls.

The evaluation according to these standards will be possible with a later update of EliteCAD AR13.

For that reason, it is recommended that the settings are already used now.

EN 15221-6 is valid right across Europe.

Internal walls: EN 15221-6: IKF

Internal walls: EN 15221-6: TGF (office extension walls)

Internal dividing walls flexible, without reference to standards (e.g. cellar separators)

Layers and object types

Wall	Object type
Load-bearing	Wall construction
Non load-bearing	Wall construction, non-bearing
Subconstruction	Wall facing subconstruction
Facing	Wall (facing)

Non-visible insulation > Subconstruction

External insulation > Facing

System-built walls

The system-built wall option has the effect of evaluating all layers in a wall together.

The measurement is taken on the surface of the wall, on the side of the wall axis drawn.

Application option system-built wall

- Partition walls drywall construction
- Prefabricated walls
- Walls in element construction.

It must be remembered that all materials are assigned to either the same trade or none.

raumtrennend

Option room-dividing

The room-dividing option limits the area in accordance with standards DIN 277, ÖNORM B1800 and SIA 416 and EN 15221-6.

The area and the floor area do not have to be identical.

The individual layers of the floor of the room definition in EliteCAD AR13 can be extended as preferred, including over the main contour.

Example of area not equal to floor area

Model: Structure EFH, Upper Storey 1 Bathroom

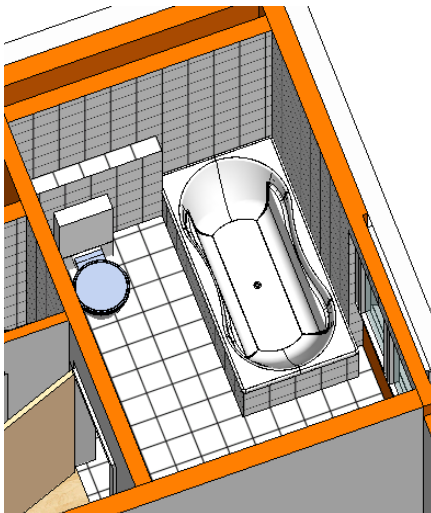

The wall parapet behind the WC is part of the room area, but is not part of the floor finish area

The area of the bath tub is part of the room area, but is not part of the floor finish area

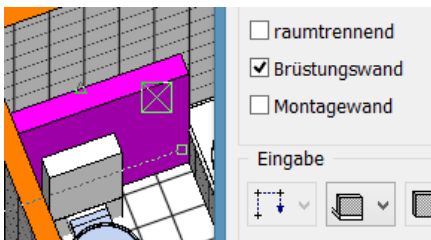

Option room-dividing must be disabled

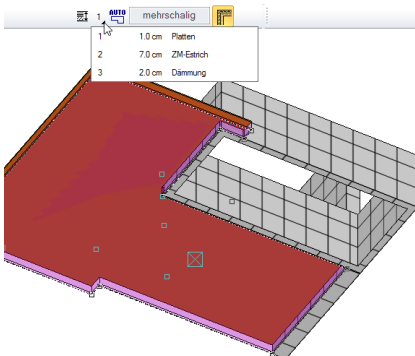

View from below:

All layers of the floor were removed in the area of the parapet wall and bathtub.

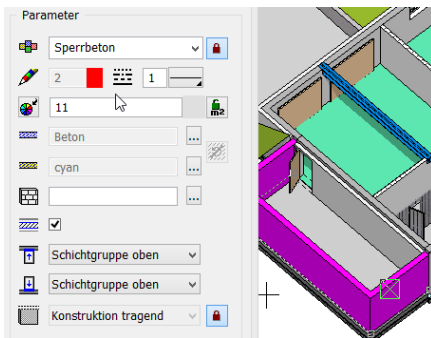

Synonyme Farben INI-Werte Te

Material

- [-] Abdichtungsbeschichtung
- [-] Abdichtungsbeton
 - Abdichtungsbeton
 - Beton wasserdicht
 - Sperrbeton
 - Wasserdichter Beton

Synonyme Farben INI-Werte Texte Optionen Objektarten

Wandschichttypen

Ortbetonbau Mauerwerk Gipswände Aussendämmschichten

Nr	Synonym
100001	Beton
100002	Abdichtungsbeton
100003	Magerbeton

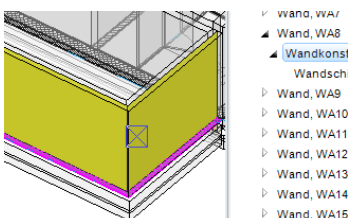

Watertight concrete walls

Model: Structure EFH, Basement External wall Store

- Waterproofing concrete > load-bearing

Waterproofing concrete is a synonym for sealing concrete

Sealing concrete is assigned to the trade in-situ concrete construction.

See also options for deduction limits and materials for [Concrete walls](#) (Chapter 7.3)

The layer types wall construction load-bearing, wall construction non-bearing and subconstruction are measured in the middle of the layer.

Display by selecting it in quantities manager.

Cost allocation rules in BIM2COST 13

C 2.1.1 Concrete walls (external)

E 1.1.1 Seals

Lists for concrete walls

2.1.04 Concrete walls by storeys/structures

2.1.05 Concrete walls by material

2.1.91 All wall layers by storeys/structures (without breakdown)

2.1.92 All wall layers by material (without breakdown)

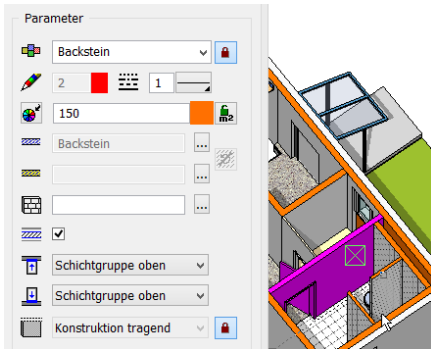

Brick walls

Brick wall, load-bearing

Standard presetting options layer types
Model: Structure EFH, GF Shower, Dividing Wall

- Brick > load-bearing

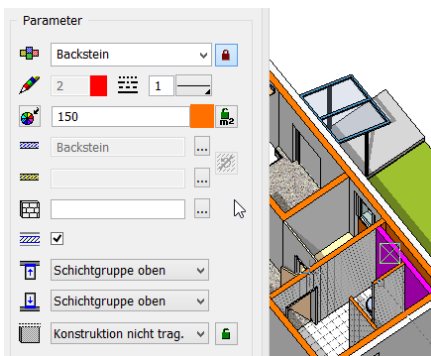

Brick wall, non load-bearing

Lock opened

- Brick
- Lock open, non load-bearing construction

Cost allocation rules in BIM2COST 13

C 2.1.2 Masonry (external for option external wall)

C 2.2.2 Masonry (internal for option internal wall)

Lists for brick walls

2.1.01 Brick walls by storeys/structures

2.1.02 Brick walls by material

2.1.91 All wall layers by storeys/structures (without breakdown)

2.1.92 All wall layers by material (without breakdown)

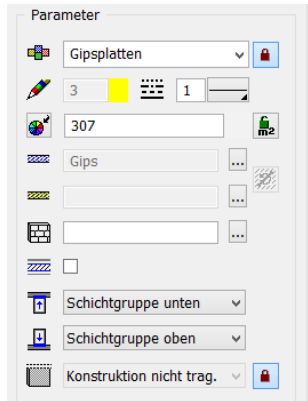

Drywall construction walls

Single-skin drywall constructions walls (plaster)

Model: Structure EFH, Upper Storey 2

- Plasterboard > non load-bearing

Cost allocation rules in BIM2COST 13

G 1.1.5 Slab walls

G 3.2.2 Subconstruction, if defined as subconstruction

Lists for drywall construction walls

2.1.11 Drywall construction walls by storeys

2.1.12 Drywall construction walls by material

2.1.91 All wall layers by storeys/structures (without breakdown)

2.1.92 All wall layers by material (without breakdown)

See also options for deduction limits and materials for [Drywall construction walls \(plaster walls, drywalls\)](#) (Chapter 10.3)

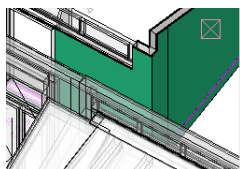
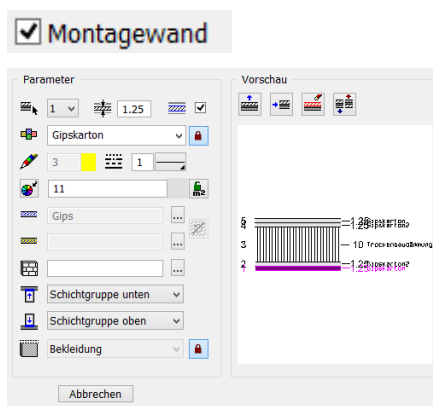

▲ Wand_WA48
 ▲ Wand (-bekleidung), WA48
 Wandschicht, WA48.1
 Wandschicht, WA48.2
 Wandschicht, WA48.3
 Wandschicht, WA48.4
 Wandschicht, WA48.5
 ▶ Wand_WA49
 ▶ Wand_WA50

Multilayer drywall construction walls, partition wall, system-built wall

Model: Structure EFH, Upper Storey 2

- System-built wall

- Plasterboard > Facing
- Plasterboard2 > Facing
- Drywall insulation > Facing
- Plasterboard > Facing
- Plasterboard2 > Facing

Cost allocation rules in BIM2COST 13

G 1.1.1 Partition walls

Lists for drywall construction walls, system-built wall

2.1.13 System-built walls drywall construction by storeys/structures

2.1.14 System-built walls drywall construction by storey

2.1.91 All wall layers by storeys/structures (without breakdown)

2.1.92 All wall layers by material (without breakdown)

Evaluation

All layers of system-built walls are evaluated together as a wall (facing).

The area is measured on the wall axis side

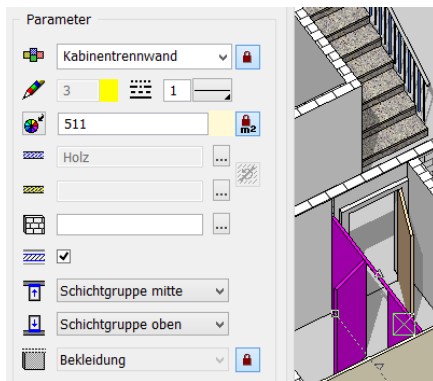

Cubicle dividing walls and similar

Model: Structure EFH, Basement Cubicle Dividing Wall

- Cubicle dividing wall > Facing
- Depending on the requirement for the room, room-separating
- Non load-bearing or flexible

Cost allocation rules in BIM2COST 13

G 1.1.3 Cubicle dividing walls

Lists for cubicle dividing walls

- 2.1.51 Other internal walls by storeys/structures
- 2.1.52 Other internal walls by storeys
- 2.1.91 All wall layers by storeys/structures (without breakdown)
- 2.1.92 All wall layers by material (without breakdown)

If a material is not listed in the options for other layers, no deduction audit is performed. See also [Different wall materials](#) (Chapter 7.3)

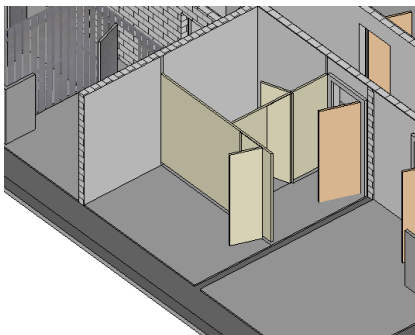

Wall type flexible

For flexible walls, the floor covering is continuous under the wall.

Separating systems, cellar part divisions

Model: Structure EFH, Basement Cellar Part Dividing Wall

- Lath partition > non load-bearing

Cost allocation rules in BIM2COST 13

G 1.1.4 Separating systems

Lists for cellar part divisions

- 2.1.51 Other internal walls by storeys/structures
- 2.1.52 Other internal walls by storeys
- 2.1.91 All wall layers by storeys/structures (without breakdown)
- 2.1.92 All wall layers by material (without breakdown)

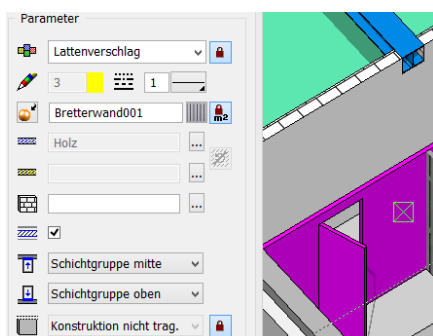

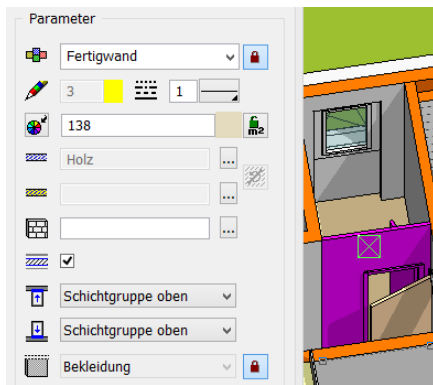

Complete dividing wall systems

Model: Structure EFH, GF Separation from store room

- Complete wall > Facing

Cost allocation rules in BIM2COST 13

G 1.1.7 Complete dividing wall systems

Lists for complete dividing wall systems

- 2.1.51 Other internal walls by storeys/structures
- 2.1.52 Other internal walls by storeys
- 2.1.91 All wall layers by storeys/structures (without breakdown)
- 2.1.92 All wall layers by material (without breakdown)

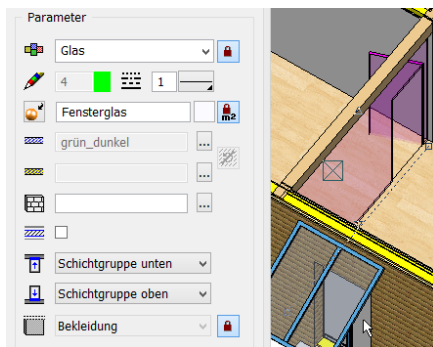

Glass walls from wall construction

Model: Structure Timber Construction, GF Division from reception

- Glass > Facing

Cost allocation rules in BIM2COST 13

G 1.1.6 Dividing walls in glass

Lists for glass walls from wall function

- 2.1.51 Other internal walls by storeys/structures
- 2.1.52 Other internal walls by storeys
- 2.1.91 All wall layers by storeys/structures (without breakdown)
- 2.1.92 All wall layers by material (without breakdown)

See also glass construction

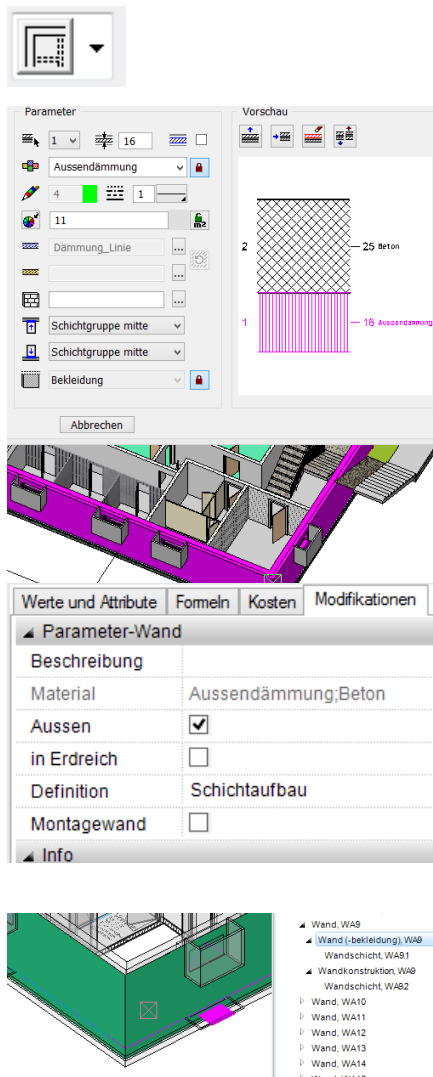

External insulation (without back-ventilated facing)

Model: Structure EFH, Basement External Wall

- External wall

- External insulation > Facing

Cost allocation rules in BIM2COST 13

E 2.2.1 External thermal insulation over terrain

E 1.2.2 External thermal insulation under terrain with in soil option

In-soil option in BIM2COST.

Facings are measured on the wall surface.

Visualization with visible deduction audit by selecting wall facing in quantities manager.

For windows, the visualization area is continuous, because this opening is not deducted.

Lists for external insulation

2.1.21 External insulation by storeys

2.1.22 External insulation by material

2.1.91 All wall layers by storeys/structures (without breakdown)

2.1.92 All wall layers by material (without breakdown)

See also options for deduction limits and materials for [External insulation](#) (Chapter 7.3)

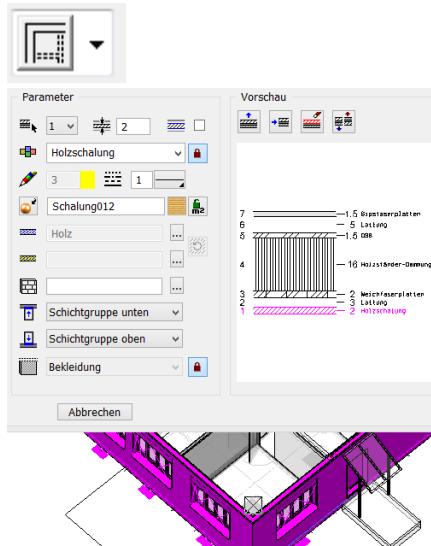

External wall timber construction

Back-ventilated wall facing

Model: Structure Timber Construction, GF External Wall

- External wall

Part timber construction external wall

- Gypsum fibre boards > Facing
- Lath > Subconstruction
- OSB > Subconstruction
- Timber partition insulation load-bearing construction

Part back-ventilated wall facing

- Soft fibreboard > Subconstruction
- Lath > Subconstruction
- Roof boarding > Facing

Visualization by selecting the wall in the CAD

The outer layers of the subconstructions are summarized and evaluated together.

The inner layers of the subconstructions are summarized and evaluated together.

External wall facing

Internal wall facing

Wall construction

Visualization by selection in quantities manager

Sub-construction external: Wall facing sub-construction

Sub-construction internal

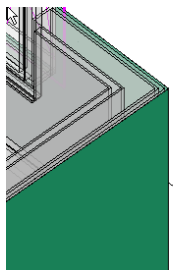

- ▲ Wand
- ▲ Wand, WA56
- ▲ W.Bekl.Unterkonstruktion, WA56.1
 - Wandschicht, WA56.2
 - Wandschicht, WA56.3
- ▲ W.Bekl.Unterkonstruktion, WA56.2
 - Wandschicht, WA56.5
 - Wandschicht, WA56.6
- ▲ Wand (-bekleidung), WA56.1
 - Wandschicht, WA56.1
- ▲ Wand (-bekleidung), WA56.2
 - Wandschicht, WA56.7
- ▲ Wandkonstruktion, WA56
 - Wandschicht, WA56.4

Wall facing external

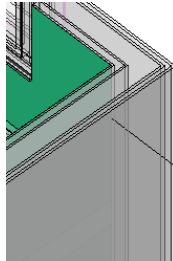

- ▲ Wand, WA56
- ▲ W.Bekl.Unterkonstruktion, WA56.1
 - Wandschicht, WA56.2
 - Wandschicht, WA56.3
- ▲ W.Bekl.Unterkonstruktion, WA56.2
 - Wandschicht, WA56.5
 - Wandschicht, WA56.6
- ▲ Wand (-bekleidung), WA56.1
 - Wandschicht, WA56.1
- ▲ Wand (-bekleidung), WA56.2
 - Wandschicht, WA56.7
- ▲ Wandkonstruktion, WA56
 - Wandschicht, WA56.4

Wall facing internal

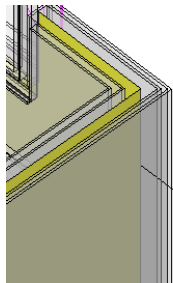

- ▲ Wand
- ▲ Wand, WA56
- ▲ W.Bekl.Unterkonstruktion, WA56.1
 - Wandschicht, WA56.2
 - Wandschicht, WA56.3
- ▲ W.Bekl.Unterkonstruktion, WA56.2
 - Wandschicht, WA56.5
 - Wandschicht, WA56.6
- ▲ Wand (-bekleidung), WA56.1
 - Wandschicht, WA56.1
- ▲ Wand (-bekleidung), WA56.2
 - Wandschicht, WA56.7
- ▲ Wandkonstruktion, WA56
 - Wandschicht, WA56.4

Wall construction load-bearing

Cost allocation rules in BIM2COST 13

C 2.1.5 Element construction in timber (external)

E 2.3.1 Timber and timber materials (external wall facing)

E 2.3.4 Coatings

E 2.3.5 Insulation for facade facings *)

G 3.2.2 Subconstructions (internal wall facing)

*) not in this example. Only if insulation is present on the external side as subconstruction.

Montagewand

This wall can also be evaluated using the option system-built wall. Then all layers are summarized and measured on the external side (wall axis).

Lists for timber external wall + back-ventilated facing

2.1.31 Other internal walls by storeys

2.1.32 Other internal walls by material

2.1.91 All wall layers by storeys/structures (without breakdown)

2.1.92 All wall layers by material (without breakdown)

List for timber external wall as system-built wall

2.1.41 External system-built walls by storeys/structures

2.1.42 External system-built walls by material

2.1.91 All wall layers by storeys/structures (without breakdown)

2.1.92 All wall layers by material (without breakdown)

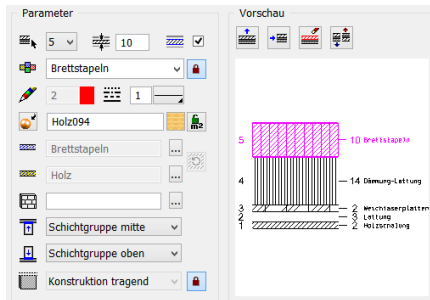

Solid timber external wall

Model: Structure Timber Construction, Upper Storey 2

- Stacked plank construction > load-bearing
- Insulation - laths > Subconstruction
- Soft fibreboard > Subconstruction
- Lath > Subconstruction
- Roof boarding > Facing

Cost allocation rules in BIM2COST 13

Part wall construction load-bearing

C 2.1.4 Solid timber walls (external)

In this model, the wall is defined as a system-built wall.

Lists for solid timber external wall

See previous section.

Internal timber walls

Timber partition wall

Model: Structure Timber Construction, GF

- Internal wall

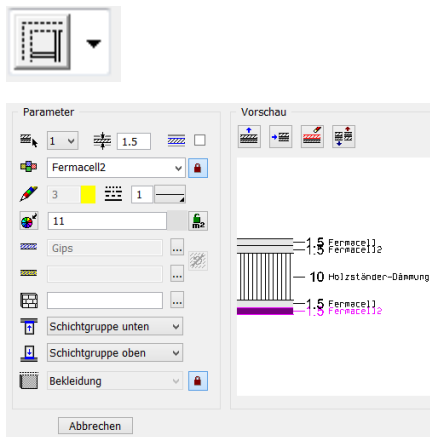

- Fermacell > Facing
- Fermacell2 > Facing
- Timber partition insulation > load-bearing construction
- Fermacell > Facing
- Fermacell2 > Facing

Cost allocation rules in BIM2COST 13

C 2.2.5 Element construction in timber (internal)

G 3.2.2 Subconstruction (wall facing, internal)

Lists for internal timber walls

- 2.1.51 Other internal walls by storeys/structures
- 2.1.52 Other internal walls by material
- 2.1.91 All wall layers by storeys/structures (without breakdown)
- 2.1.92 All wall layers by material (without breakdown)

Lists for internal timber walls, system-built wall

- 2.1.61 Other internal system-built walls by storeys/structures
- 2.1.62 Other internal system-built walls by material
- 2.1.91 All wall layers by storeys/structures (without breakdown)
- 2.1.92 All wall layers by material (without breakdown)

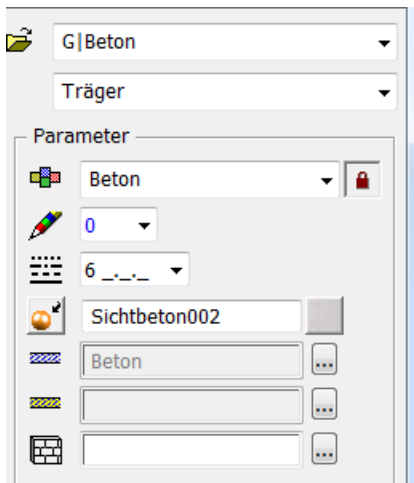

5.6 Girder/Binding beam

Layer

- Material
- Evaluating finishes: Active: Slab finish to side and below
- External support
- Connecting with storey slab or level slab
- Free height reference

Girders/binding beams are evaluated for object type girder construction

Properties for room

Girders/binding beams from this function are not room-dividing

BIM2COST

In the eBKP-H standard there is no cost component for girders/binding beams

List for girders/binding beams

2.4.21 Girders

5.7 Girder with wall function

Using the wall function, girders can be created with height reference wall to ceiling (in the frame bottom left) with girder enabled (top frame); these girders are room-dividing or non room-dividing (frame bottom right).

This function can be used to create multilayer girders.

- Option room-dividing
 - Option girder (must be set)
 - Option system-built wall
-
- Height reference to ceiling (2nd from left)
 - External/Internal

Girder	Object type
Load-bearing	Sub-construction
Non load-bearing	Wall construction, non-bearing
Subconstruction	Wall facing subconstruction
Facing	Wall (facing)

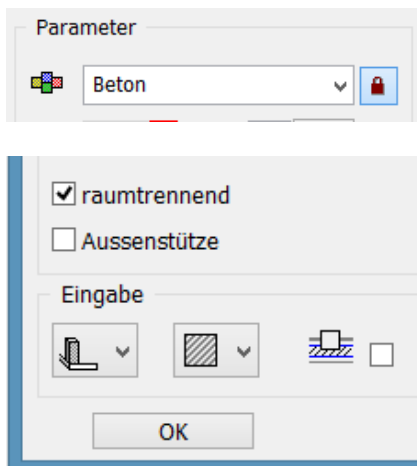

5.8 Columns

- Material
- Option room-dividing
- External/Internal
- Wall removing

Columns are evaluated as object type column, pillar

Cost allocation rules in BIM2COST 13

C 3.1.x External column by material

C 3.2.x Internal column by material

Lists for columns

2.4.11 Columns

5.9 Chimneys

BIM2COST

Chimneys are evaluated. Under the current eBKP-H catalogue, they are not part of any cost component.

But chimneys can be allocated to a separate element type.

Material.

Note

Chimneys from the EliteCAD library contain additional information which can be evaluated.

Lists for chimneys

2.4.41 Chimneys

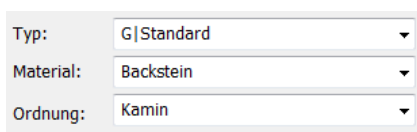

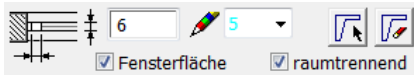

5.10 Glass elements, vertical

- Vertical glass elements can be defined as room-dividing.
- Using the option window area, it is possible to define whether these are to be counted for the room description.
- Glass elements are listed in the windows report.

Supplementary definitions in BIM2COST

- Material
- External/Internal

Glass elements are evaluated for the object type glass construction.

Cost allocation rules in BIM2COST 13

- G 1.1.6 Dividing walls in glass (internal)
- E 2.4 Facade system (external)
- E 3.1.x Windows by material

5.11 Glass elements, inclined and horizontal

For inclined and horizontal glass elements, the room-dividing option is not available. Accordingly, they do not divide rooms.

Glass elements are also not height-limiting.

For a glass element, a height limit can be created using a [height restriction](#).

Typ:	 Standard_Flügel
Material:	Holz
Ordnung:	Fenster

5.12 Windows

In order for the material to be shown correctly, the material must be defined in the window parameter (e.g. wood-metal).

Notes for evaluation

- CAD allocates the windows to the individual rooms. Accordingly, a window must always be placed in a room-dividing wall construction. This applies in particular for walls that lie above one another. For walls that lie above one another, only one wall may be defined as room-dividing.
- Windows that are not clearly assigned to one room are listed in the window list in the storey, without a room assignment. These are not listed in the room sheet list.

Problems with room assignment

- The side frames of the window are located in the area of room-dividing internal walls.
- A room-dividing parapet wall is located in the window area.
- A room division runs to the window.

Cost allocation rules in BIM2COST 13

On windows, an evaluation is made as to whether the window has sunscreening (slat blinds or roller shutters).

A window in a defined external wall is automatically evaluated with the property external.

- E 3.1.x Window(s) external by material
- E 3.1.7 Windowsills
- E 3.3.2 Slat blinds
- E 3.3.3 Window rollers
- G 1.3.x Window(s) internal by material
- G 5.3.1 Curtain pelmets
- G 5.3.2 Window ledges
- G 5.3.3 Intrados lining

Lists for windows

In the initial selection of the window list with images, the graphics are calculated and saved to the database. This calculation requires some time. If this list is selected again, the calculation is not repeated.

- 3.1 Windows list
- 3.2 Windows list with images
- E 3.5 Windowsills, external
- 3.6 Windowsills, internal (window ledges)

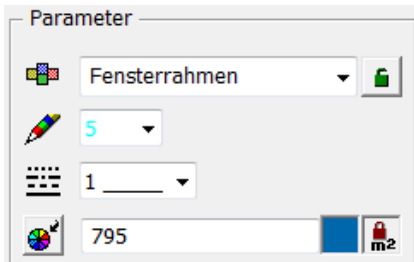
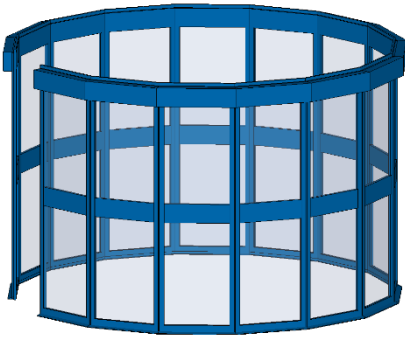

Window in wall

- Instead of a glass element, a wall can be created using the thickness and size of the window-frame into which a window is then inserted.
- For corner windows (window strips), window overlaps can be avoided by doing so, as these can lead to faulty room contour calculations.

Type:

For the wall parameter, the entry is made under the material parameter "window-frame". This ensures that these walls are listed in the list "Different walls" with the material window-frame. Example model in the project glass constructions, model special glass constructions.

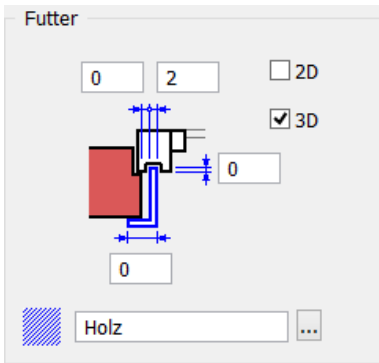
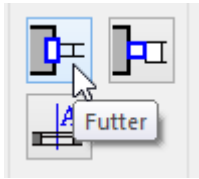

Bibteil:

5.13 Skylights

The material is set in the detail parameter linings.

- Material
- Lib part: The name of the Lib part becomes the file name.

Cost allocation rules in BIM2COST 13

F.2.1.1 Skylights

Lists for skylights

- 3.1 Windows list
- 3.2 Windows list with images

Nr.	Rollo Einheit	Form Raum	Raumnr.	Material Typ Beschreibung
FE25	none	Rechteck		Holz



Velux - P10 94x160



5.14 Roof skylight from library

Cost allocation rules in BIM2COST 13

F 2.1.3 Skylights for flat roofs

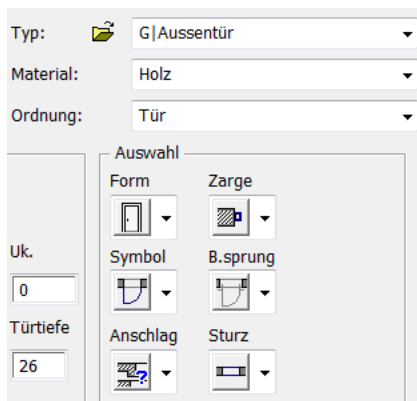
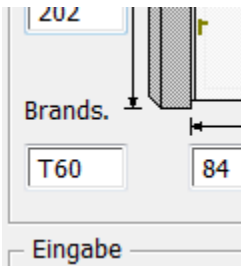

5.15 Doors

- CAD allocates the doors to the individual rooms.
- The fire protection information is exported to the database and shown in the lists.

Doors in external walls are automatically evaluated as external.

Cost allocation rules in BIM2COST 13

The following settings are used in BIM2COST:

- Material
- Internal/External
- Opening type
- Stop
- Shape
- Frame
- Fire protection

E 3.2.1 External doors, external gates in timber

E 3.2.2 External doors, external gates in metal

G 1.4.1 Framed doors

G 1.4.2 Casement doors

G 1.4.3 Lined doors

G 1.4.4 Sliding doors

G 1.4.5 Fire protection doors

Lists for doors

3.3 Door list

3.4 Door list with images

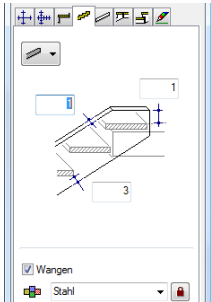

Werte und Attribute	Formeln	Kosten	Eigenschaften
▲ Parameter-Stiege			
geschossübergre	<input checked="" type="checkbox"/>		
Material Laufplatt			
Material Wange		Stahl	
Material Auftritte		Holz	
▲ Info			
Layer		Treppe	

5.16 Stairs

Stair evaluation

Materials

The material is evaluated for stairs using the following sequence:

1. Stair flight plate
2. Cheek
3. Stair finish

The material is listed in the lists.

Using this, allocation to the correct cost component is possible in BIM2COST.

The material can be changed in BIM2COST in the properties window.

Cost allocation rules in BIM2COST 13

C 4.2.x Stairs by material

Lists for stairs

Listing by material

Detailed evaluation separately by stair type, run and landings.

[Individual landings](#) are listed in the ceilings list.

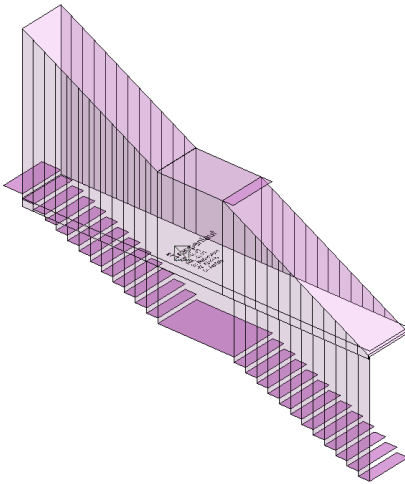

Rooms and room finishes for stairs

The stair undersides are height-limiting for a room.

Effect:

- Limiting room height:
in the living space calculation, this room height is taken into account.
- Room volume:
The net room volume NRI (DIN 277 + ÖNORM B1800) or the net building volume NGV (SIA 416) is limited.
- Room finishes:
Wall finishes are limited to the side.
Ceiling finishes and floor finishes are calculated for the stair landing.

Room definition for stairs

The room definition for stairs must always be set in the upper storey. As an example, an extract from DIN 277:

“Areas of stairs and ramps (...) are to be allocated to the level above them, insofar as they do not intersect there with other areas.”

Thus no separate room definition needs to be set below the lowest stair. The space under the stair is limited in height by the stair.

Room volume calculation (NRI or NGV)

The net room volume for stairs is always fully allocated to the upper storey in the lists.

Individual landings for multiple-flight stairs

Multiple-flight stairs can also be created from individual runs. The landings between must then be created using the CAD floor function with type [Stair landing](#). See previous section.

The evaluation is then similar to the usual stair functions with landing:

- Room heights and room volume limit
- Ceiling finishes below landing (illustration with view upward)
- Floor finishes on landing
- Wall finishes interrupted for landing

Individual landings are listed in the foundations and ceilings list.

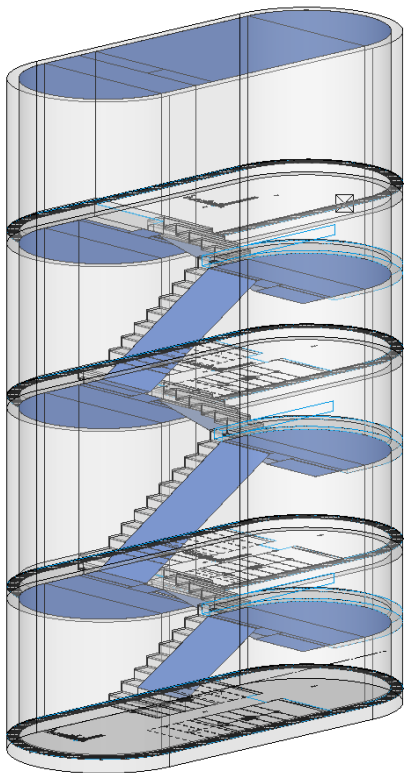

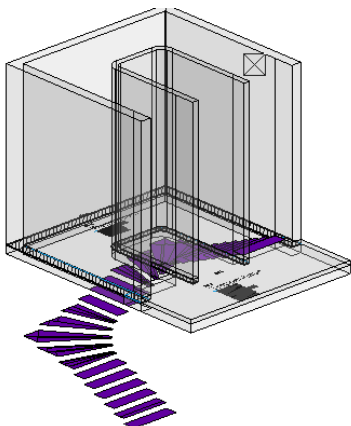
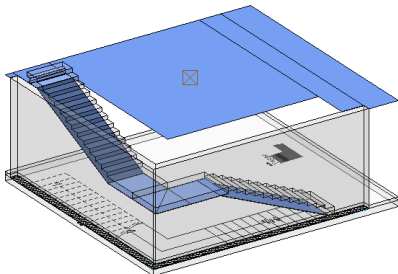
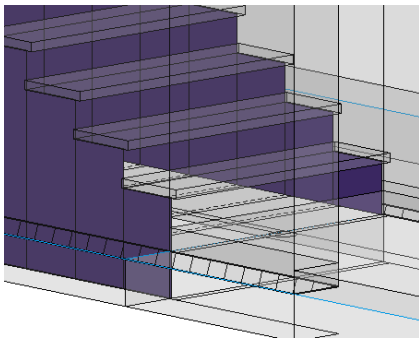
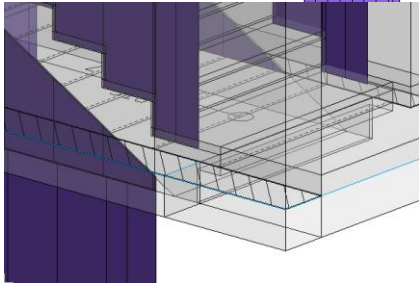
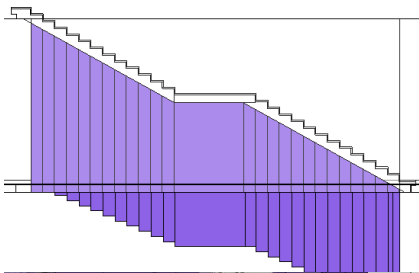

Wall finishes for stairs

Where stairs adjoin a wall, the wall surface (plaster) is interrupted. The wall finish above the stair is calculated in the upper storey. The wall finish below the stair is calculated in the lower storey. This means it is possible to differentiate between wall finishes. The areas for wall finishes uses measured values.

The wall finish for solid stairs is cut out from the bottom view to the lower edge of the stair finish.

For stairs with cheeks, the wall finish and open stairs are separated at the bottom edge of the step.

However, if in BIM2COST the wall finish is to be calculated as continuous for the stairs, then this can be performed using an allocation rule:

Cheek length times stair depth.

Alternatively, the stair can be drawn with a minimum spacing to the wall.

Ceiling finishes for stairs

Ceiling finishes are calculated using the measured area below stairs and storey/level floors and stair landings.

Floor covering finishes for stairs

Stairs are evaluated to the lower storey.

Accordingly, a room definition must be set in the upper storey.

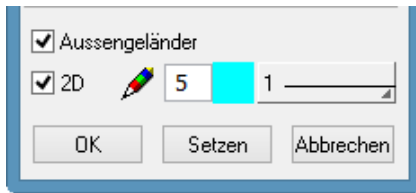

5.17 Banisters

- Option external/internal

Cost allocation rules in BIM2COST 13

F 2.2.1 Banister, external

G 5.4.2 Banister, internal

Lists for banisters

2.4.61 Banister

5.18 Installations

Library parts from the installation CD

- Library parts (2D model for objects) are described as installations.
- Plan graphic symbols etc. are not described as installations.

BIM2COST

Library parts from the EliteCAD library are evaluated.
For the standard allocation rules, the marking libname is used.

Own installations

Menu Layout > Installation

Describe the object as an installation

Menu Layout > Installation

- Type
- For the evaluation of own library parts, it is advised to define the following:
- Order (becomes the layer name)
- Name
- Description
- Material

Note:

Classes (#C), groups (#G), level (#L) are only available if in the CAD the option select using group/class/level is enabled for Options > Work parameter(s) > Edit (not recommended).

Werte und Attribute	
Bezeichnung	Wert
#C	Mobiliar
#G	Mobiliar
#L	usm
#P	usm 150x75
Beschreibung	Tisch
Bibliotheksname	
Freies Objekt	Nein
Geschoss Nr.	0
Layer	Mobiliar
Material	Glas
Materialgruppe	Glas
Name	usm 150x75

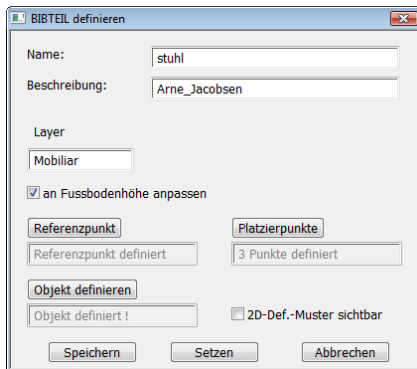

Own installations as library parts

Menu Extras > Define LIB. PART

For own library parts, these are automatically defined as installations when saving if the option “Adjust to floor height” is selected.

When saving, the library name with the marking bibname (save path with file name) is added automatically.

Similarly, the library part is given the marking object with value equipment.

Cost allocation rules in BIM2COST 13

Cost component D Engineering and G Extension

- All cost components counted as a unit, e.g. D 8.1 Fixing device, appliance (sanitary)
- G. 5.1 Fitted cupboard, shelf with the underlying element type groups
- G. 5.2 Fitted kitchen, with the underlying element type groups:
 - G 5.2.1 Furniture
 - F 5.2.2 Cover
 - G 5.2.3 Appliances

Notes for kitchen

For the standard rules in BIM2COST, via the room name there is an allocation to G 5.2 Fitted kitchen

Lists for installations

4.5 Installations by room

5.19 Help functions

Room separator

Marking: object, value roomsep.

Room separators may not be set along room-separating walls. No wall finish (plaster) is calculated along room separators. Accordingly, walls are to be defined as room-separating.

Height definition

New feature for EliteCAD AR13:

The height definition is an invisible roof. It is set similarly to the normal roof:

- Roof thickness= 0.
- 3D colour = 0
- Hatching with Pen 0

This hatching is only shown under the height in accordance with

Options > Work parameters > Drawing > Section parameters for floor plan imaging

In the CAD, the hatching makes it easier to select and identify the set height limit.

The basic setting of EliteCAD AR13 contains a hatching parameter for this, parallel or invisible.

Height definitions (roofs) with these settings are not evaluated.

Height definition for non-vertical glass elements.

If the room and/or building volume is to be limited above a glass element, a height definition must be set.

Height definition for skylights from library

The skylights present in the library are not height-limiting. A height definition must be set.

Skylights created using the skylight function do not require a height definition

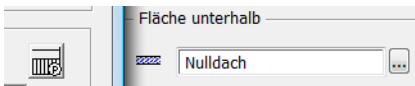



Height definition for external rooms

See also course example [Room volume for external rooms](#)

DIN 277 + ÖNORM B1800, Area/Area type c:

Set height definition on upper edge of the limiting construction parts (banister, parapet etc.)

SIA 416:

Set height definitions on upper edge of floor and the limiting construction parts (at floor height and on wall parapets).

SIA 416 does not recognize external room volume for external rooms, but construction volume and room areas and construction areas.

However, if the height definition is deliberately set higher, then an external net area volume (ANGV) and external building volume (AGV) is calculated (no standard descriptions).

Notes

- The volume is always determined using the storey height in accordance with the structure settings. This is only limited by a storey or level floor, roof or a height definition.
- If only max. room height is defined for the room description, the volume above this up to the storey height is calculated as part of the construction volume (suitable for installed ceilings).
- A height definition limits both volumes to this height.

6. Adding additional properties

Description

Using the copy parameters function, the property description can be added to all construction parts. This property is then output in the lists. This property can be used in BIM2COST for allocation rules.

Type

The property is later implemented. The lists are already prepared for this property.

Examples

Description for windows

Model: Structure Basement

- Copy parameters
- Select window

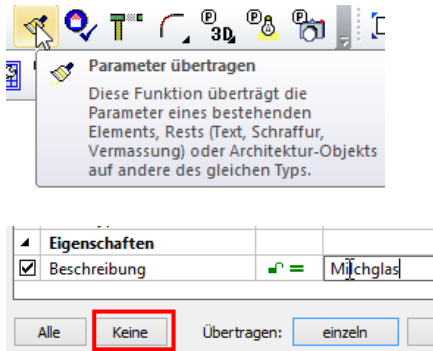

- “None” button
- Enable description
- Enter description
- “Individual” button
- Select the same window and additional windows if desired.
- Cancel function

Evaluation model list:

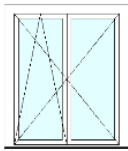
Nr.	Rollo Einheit	Form Raum	Raumnr.	Material Typ Beschreibung
FE14	Ja	Rechteck Dusche	EG-07	Holz Milchglas
				
Total	Fenster	1		

Description for skylights

The library name is transferred by the program as the description.

Fenstergrösse 87 x 153 cm

Nr.	Rollo Einheit	Form Raum	Raumnr.	Material Typ Beschreibung
FE23	none	Rechteck		Holz



Velux - P10 94x160

Description for roof truss

Fascia boards

In the model, the roof edges are recorded using the roof truss functions.

Beam function with description fascia board

Rafter function with description fascia board

Balken

3 cm x 29 cm

Nr.	St.	Neig.	Querschnitt	Typ	Beschreibung
BA10.1	1	0 °	3 cm x 29 cm		Sparren- Stimbrett
BA8.1	1	0 °	3 cm x 29 cm		Sparren- Stimbrett
Total	2				

Description for girders

Girder in basement

Stahl

Nr.	Querschnitt	Aussen	Typ	Beschreibung
UZ1	0.30 m x 0.29 m	Nein		HEA 300
Total				

7. Defining 3D objects as a construction part

7.1 Introduction

Customary 3D objects such as boxes, 3D surfaces etc. can be defined as a construction part.

The scope of this function is still at the start of development, and will be expanded and optimised in further CAD updates.

In the first release of EliteCAD AR13, therefore, most items must be set manually. For this, some mandatory entries are also required.

Therefore, this scope of function is primarily suitable for construction parts which cannot be created with the normal construction part functions.

The entries are saved and can also be used in BIM2COST for the evaluation.

7.2 Tools

Property windows

Menu View > Window > Properties

Ctrl + 6 or Strg. + 6

The property window is empty

Procedure

- Select 3D object. With few exceptions, the construction parts created using the construction part functions cannot be used.
- Add a property

Different definitions can be made using the dataset window

- Dataset:
 - A saved setting can be transferred
- Evaluation
 - Object types

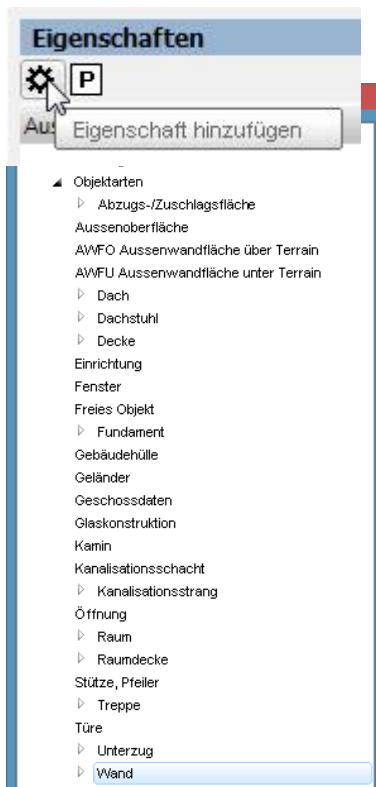
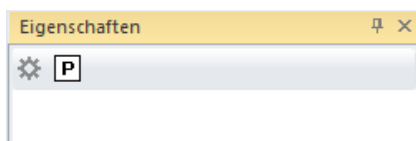

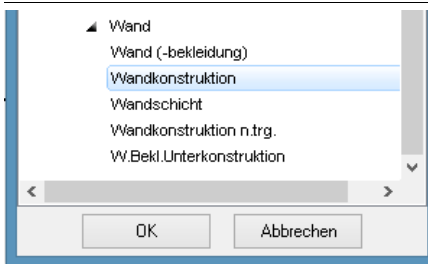

- Select object type
- Accept using OK

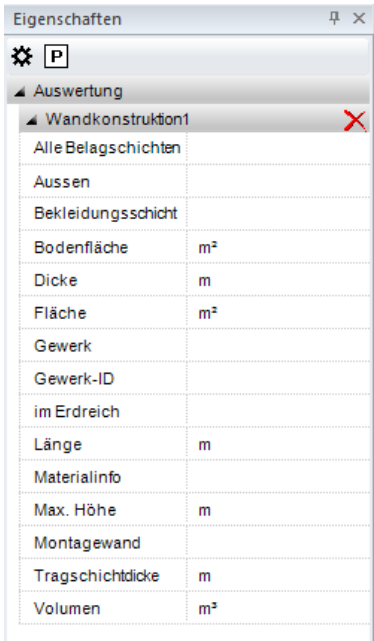

- Type can be deleted with X
- Execute entries

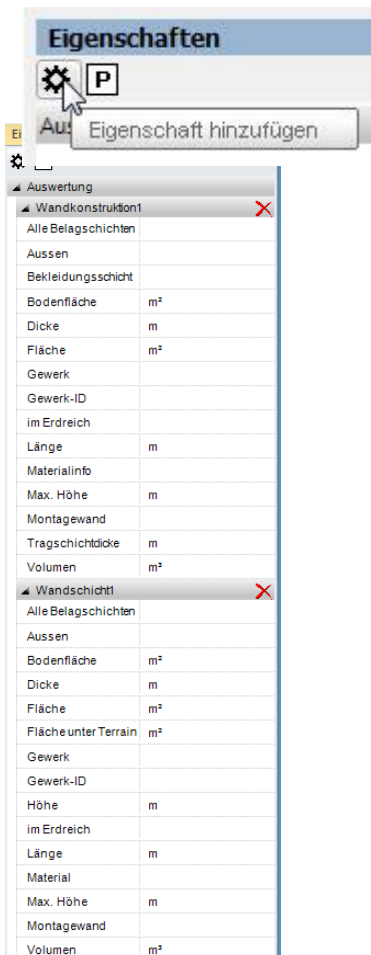

- Record additional object type
For certain construction parts, depending on the evaluation desired, two object types may need to be recorded. (being optimized in later updates)

Measurement functions

In order that the measured values can be copied and input into the entry fields, CAD should be switched to the metre unit

Volume measurement function

Menu Info > Measure > Volume

- Construct 3D object individually

- Calculate
- Copy calculated value for volume
- Enter copied value in the property window.

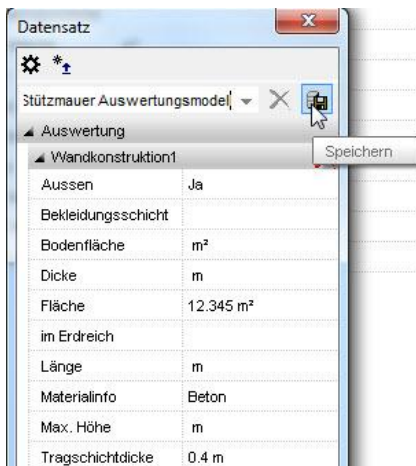
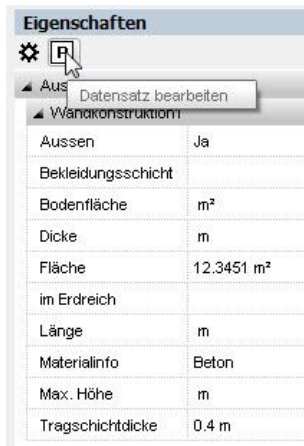

Dataset

Save property as dataset

In order for the input values to remain stored for later model variants, they can be saved as a dataset.

- Edit dataset
- Copy the current properties into the new window
- Enter and save the dataset name
- The input values are saved with this name

Now the saved dataset is available for later entries (including for other models).

Add a saved dataset (properties) to an object

- Select 3D object.
- Add a property
- Select the saved dataset

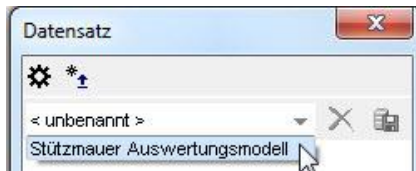

Edit and delete dataset

Saved datasets can be edited in the properties window.

The dataset is selected in the pull-down menu.

The dataset can be deleted using the delete button.
 Changed entries can be saved using the save symbol.
 All input values can be altered.

7.3 Application

The following instruction applies for EliteCAD AR13 without updates. Optimizations are being built into later updates which produce simplifications in the application.

Saved datasets

When EliteCAD AR13 is installed, prepared datasets for various construction parts are also supplied.

These contain values which need to be modified.

For quantities, in most cases the value 99 is entered; this needs to be modified.

It is not necessary to fill every value field. These are therefore empty in the datasets.

Requirements

Multilayer construction parts from 3D objects

- Only one layer type may be defined per 3D object.
This means that a 3D object must be created for each layer type for multilayer construction parts.

Two object types are needed

- Layer type (e.g. wall construction)
The layer type is needed as the lists are organised by layer types.
BIM2COST requires the layer type for allocation to cost components.
- Layer(s) (e.g. wall layer)
Several layers can be added.
In the lists, the layers are subordinate to the layer types.

Other construction parts from 3D objects

One object type is sufficient

Construction parts from the construction part functions

No further allocations can be made using this function.

Room definitions from the architecture function

Room finishes and living spaces can be added.

However, these are not listed in the living space verification.

7.4 Multilayer construction parts

Walls

Brick walls

- Select 3D object.
- Add a property
- Brick walls dataset

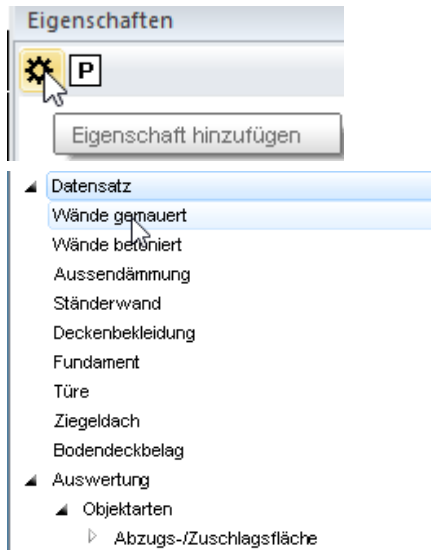

Wandkonstruktion1	
Alle Belagschichten, Anzahl	
Aussen	Nein
Bekleidungsschichten	
Bodenfläche	m ²
Dicke	0.15 m
Fläche	99.0 m ²
Gewerk	Wände gemauert
im Erdreich	
Länge	m
Materialinfo	Kalksandstein
Max. Höhe	m
Montagewand	Nein
Tragschichtdicke	m
Volumen	m ³
Wandschicht1	
Alle Belagschichten, Anzahl	
Aussen	Nein
Bodenfläche	m ²
Dicke	0.15 m
Fläche	99.0 m ²
Fläche unter Terrain	m ²
Gewerk	Wände gemauert
Höhe	m
im Erdreich	
Länge	m
Material	Kalksandstein
Max. Höhe	m
Montagewand	Nein
Volumen	m ³

- Wall construction (layer type)
- External/Internal
- Thickness
- Surface
- Trade
- Material, overarching term
- System-built wall Yes/No
- Wall layer (layer)
- External/Internal
- Thickness
- Surface
- Trade
- Material (synonym)
- System-built wall Yes/No

Auswertung	
Wandkonstruktion1	
Alle Belagschichten	
Aussen	Ja
Bekleidungsschicht	
Bodenfläche	m ²
Dicke	0.2 m
Fläche	99.0 m ²
Gewerk	Wände betoniert
im Erdreich	
Länge	m
Materialinfo	Beton
Max. Höhe	m
Montagewand	Nein
Tragschichtdicke	m
Volumen	m ³
Wandschicht1	
Alle Belagschichten	
Aussen	Ja
Bodenfläche	m ²
Dicke	0.2 m
Fläche	99.0 m ²
Fläche unter Terrain	m ²
Gewerk	Wände betoniert
Höhe	m
im Erdreich	
Länge	m
Material	Beton
Max. Höhe	m
Montagewand	Nein
Volumen	m ³

Concrete walls

- Wall construction (layer type)
- External/Internal
- Thickness
- Surface
- Trade
- Material, overarching term
- System-built wall Yes/No
- Volume
- Wall layer (layer)
- External/Internal
- Thickness
- Surface
- Trade
- Material (synonym)
- System-built wall Yes/No

Wand (-bekleidung)1	
Alle Belagschichten	
Aussen	Nein
Bodenfläche	m²
Dicke	0.125 m
Fläche	99.0 m²
Fläche unter Terrain	m²
Gewerk	Trockenwand
im Erdreich	
Länge	m
Materialinfo	Gipskarton; Trockenbaudämmung; Gipskarton
Max. Höhe	m
Montagewand	Ja
Volumen	m³
Wandschicht1	
Alle Belagschichten	
Aussen	Nein
Bodenfläche	m²
Dicke	0.012 m
Fläche	99.0 m²
Fläche unter Terrain	m²
Gewerk	Trockenwand
Höhe	m
im Erdreich	
Länge	m
Material	Gipskarton
Max. Höhe	m
Montagewand	Ja
Volumen	m³
Wandschicht2	
Alle Belagschichten	
Aussen	Nein
Bodenfläche	m²
Dicke	0.1 m
Fläche	99.0 m²
Fläche unter Terrain	m²
Gewerk	Trockenwand
Höhe	m
im Erdreich	
Länge	m
Material	Trockenbaudämmung
Max. Höhe	m
Montagewand	Ja
Volumen	m³
Wandschicht3	
Alle Belagschichten	
Aussen	Nein
Bodenfläche	m²
Dicke	0.012 m
Fläche	99.0 m²
Fläche unter Terrain	m²
Gewerk	Trockenwand
Höhe	m
im Erdreich	
Länge	m
Material	Gipskarton
Max. Höhe	m
Montagewand	Ja
Volumen	m³

Partition wall, system-built wall

- Wall facing (layer type)
 - External/Internal
 - Thickness
 - Surface
- Trade
 - Material, overarching term from all layers
 - System-built wall Yes
- Wall layer1 (layer)
 - External/Internal
 - Thickness
 - Surface
 - Trade
 - Material (synonym)
 - System-built wall Yes/No
- Wall layer2 (layer)
- Wall layer3 (layer)

Wand (-bekleidung)1	
Alle Belagschichten	
Aussen	Ja
Bodenfläche	m ²
Dicke	0.2 m
Fläche	99.0 m ²
Fläche unter Terrain	m ²
Gewerk	Aussendämmung
im Erdreich	Nein
Länge	m
Materialinfo	Aussendämmung
Max. Höhe	m
Montagewand	Nein
Volumen	m ³
Wandschicht1	
Alle Belagschichten	
Aussen	Ja
Bodenfläche	m ²
Dicke	0.2 m
Fläche	99.0 m ²
Fläche unter Terrain	m ²
Gewerk	Aussendämmung
Höhe	m
im Erdreich	Nein
Länge	m
Material	Aussendämmung
Max. Höhe	m
Montagewand	Nein
Volumen	m ³

External insulation

- Wall facing (layer type)
- Wall layer (layer)

Fundamentkonstruktion	
Alle Belagschichten	
Aussen	
Breite 1	m
Breite 2	m
Dicke	0.25 m
Effektive Fläche	99.0 m ²
Fläche	99.0 m ²
Form	
Gefälle %	%
Gewerk	
im Erdreich	
Materialinfo	Beton
Rohe Deckenoberk	
Umfang	m
Volumen	99.0 m ³
Fundamentschicht1	
Alle Belagschichten	
Aussen	
Breite 1	m
Breite 2	m
Dicke	0.25 m
Effektive Fläche	99.0 m ²
Fläche	99.0 m ²
Form	
Gefälle %	0.0 %
Gewerk	
im Erdreich	
Material	Beton
Rohe Deckenoberk	
Umfang	m
Volumen	99.0 m ³

Foundation

- Foundation construction (layer type)

- Thickness
- Measured surface
- Surface

- Incline

- Material, overarching term

- Volume
- Foundation layer (layer)

- Thickness
- Measured surface
- Surface

- Incline

- Material

- Volume

▲ Bodenkonstruktion	
Alle Belagschichten	
Aussen	Nein
Breite 1	m
Breite 2	m
Dicke	0.2 m
Effektive Fläche	99.0 m ²
Fläche	99.0 m ²
Gefälle %	0.0 %
Gewerk	Betondecke
im Erdreich	
Materialinfo	Beton
Rohe Deckenoberk	
Umfang	m
Volumen	99.0 m ³
▲ Bodenschicht, Deckel	
Alle Belagschichten	
Aussen	Nein
Breite 1	m
Breite 2	m
Dicke	0.2 m
Effektive Fläche	99.0 m ²
Fläche	99.0 m ²
Gefälle %	0.0 %
Gewerk	Betondecke
im Erdreich	
Material	Beton
Rohe Deckenoberk	
Umfang	m
Volumen	99.0 m ³

Concrete slab

- Floor construction (layer type)
- External/Internal
- Thickness
- Measured surface
- Surface
- Incline
- Trade
- Material, overarching term
- Volume
- Wall layer (layer)
- External/Internal
- Thickness
- Measured surface
- Surface
- Incline
- Trade
- Material
- Volume

▲ Bodenbekleidung	
Alle Belagschichten	
Aussen	Nein
Breite 1	m
Breite 2	m
Dicke	0.015 m
Effektive Fläche	99.0 m ²
Fläche	99.0 m ²
Gefälle %	0.0 %
Gewerk	
im Erdreich	
Materialinfo	Gipskarton
Rohe Deckenoberk	
Umfang	m
Volumen	m ³
▲ Bodenschicht, Decke1	
Alle Belagschichten	
Aussen	Nein
Breite 1	m
Breite 2	m
Dicke	0.015 m
Effektive Fläche	99.0 m ²
Fläche	99.0 m ²
Gefälle %	0.0 %
Gewerk	
im Erdreich	
Material	Gipskarton
Rohe Deckenoberk	
Umfang	m
Volumen	m ³

Slab facing

- Floor facing (layer type)
- External/Internal
- Thickness
- Measured surface
- Surface
- Incline
- Material, overarching term
- Wall layer (layer)
- External/Internal
- Thickness
- Measured surface
- Surface
- Incline
- Material

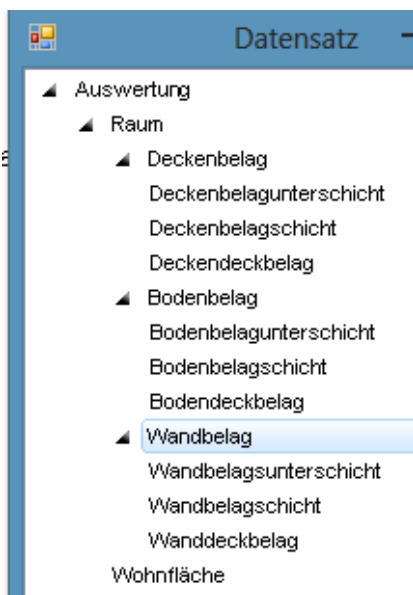

Bodenbelagschicht1	
Alle Belagschichten	
Aussen	Nein
Dicke	0.01 m
Effektive Fläche	99.0 m ²
Fläche	99.0 m ²
Gefälle %	0.0 %
Gewerk	
Material	Platten
Umfang	m
Volumen	m ³
Bodendeckbelag	
Alle Belagschichten	
Aussen	Nein
Dicke	0.01 m
Effektive Fläche	99.0 m ²
Fläche	99.0 m ²
Gefälle %	0.0 %
Gewerk	
Materialinfo	Platten
Umfang	m
Volumen	m ³

Additional floor finish area for existing room definition

Note:

The room definition is the only architecture function where additional object types can be added. The selection is, however, reduced to the room object types. No saved datasets can be called up

- Select existing room definition

- Floor finish layer (layer)

- External/Internal
- Thickness
- Measured surface
- Surface
- Incline

- Material

- Floor covering finish

- External/Internal
- Thickness

- Measured surface
- Surface
- Incline

- Material, overarching term

8. Control functions

8.1 Check room contours

Notes on room-separating functions

In order for the room contours to be determined by CAD, the following rules must be respected:

- Room-separating elements must not overlay one another.
- No room separations along room-separating walls or room-separating glass elements.
- No room-separating glass element above room-separating walls. The glass element should then not be defined as room-separating.

Check evaluation contours

Menu Extras > Evaluation > Check evaluation contours

Toolbar Evaluation > Check evaluation contours

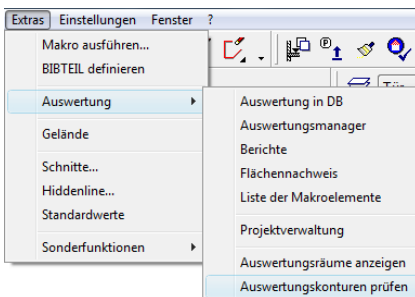

This function creates new contours in the room-check-contours layer.

- Each storey must be constructed separately.
- All layers are hidden. The CAD shows only the created layers “room-check-contours” and “error”.
- Each individual contour corresponds to a room contour. If the CAD has succeeded in correctly determining the room contour, the contour corresponds to a closed polygon.
- If a room description has been set previously, the polygon is hatched.
- Incorrect contours can be tested using the function check 2D model.
- For room descriptions that are duplicated or that cannot be allocated to a room contour, the problem is indicated using a red triangle with a diagonal line.
- Incorrect contours are displayed in yellow and are located in the error layer.
- The perimeter contour must lie outside all room contours (on the external side of the building). This contour corresponds to the storey floor area (gross storey area). Multiplied by the storey height, this produces the gross room volume. Where the perimeter contour does not include all room contours, negative values are evaluated.
- Delete the room-check-contours + error patterns with delete image (unless additional layers were constructed).

This function is similarly useful to display cavities. Non-hatched areas for cavities have no room definition and are then allocated to the construction area and to the construction volume.

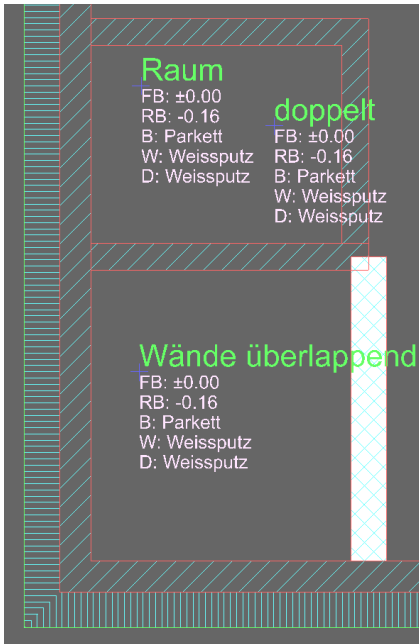

Example of duplicated room definition

Example of superimposed room-separating walls

Check room contours:

Duplicate room definition is displayed

White error contours arise if walls are superimposed.

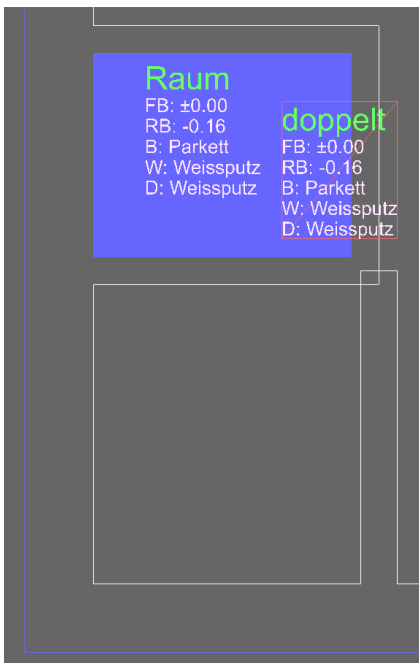

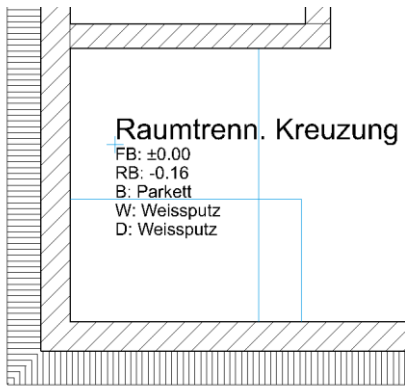

Example of error with room separators

Here room separators intersect. They would need to be interrupted at the crossing point.

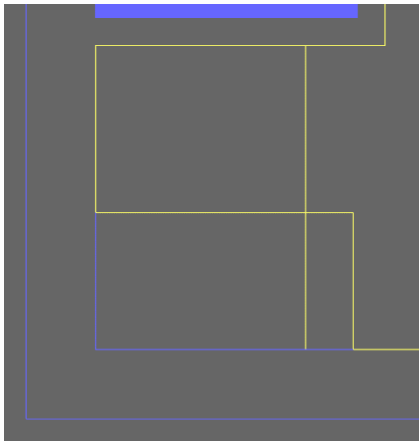

Using yellow error contours, the display indicates that an error involving room separators is present.

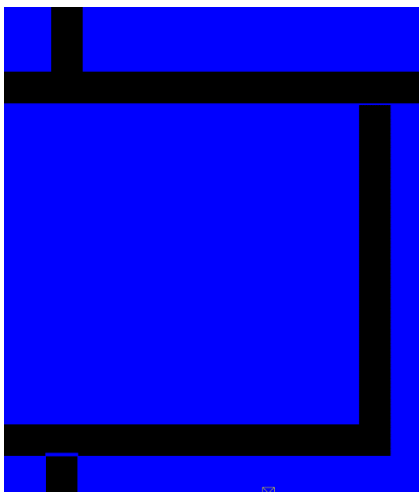
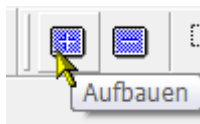
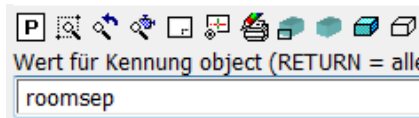
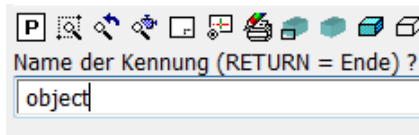
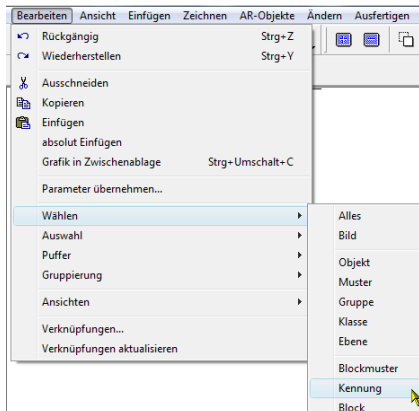

Stripping out evaluated contours

Error search

Room separators along or in room-separating construction parts

- Several superimposed room separators create errors.
- Room separations along room-separating walls, and glass elements must be deleted.

Show room separators

Menu Edit > Select > Identification

Marking object,

Value roomsep

Use [RETURN] [RETURN] to exit selection

and display using the Show Selection button.

Unclean wall junctions

The check evaluation contours function makes open (top right) and overlapping objects (below) visible.

These errors can also lead to consequential errors in other room areas. For that reason, unclean wall junctions must firstly be stripped out.

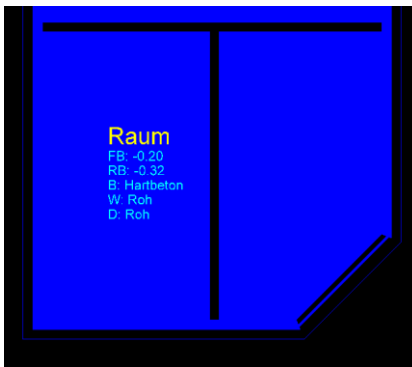
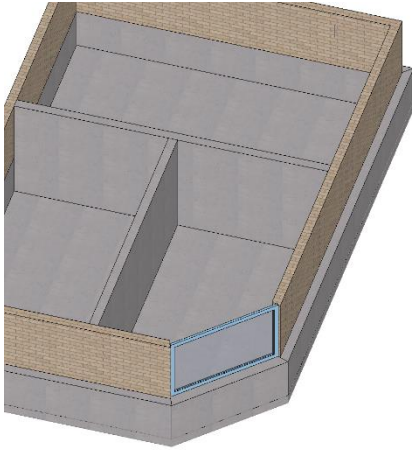

Room-separating objects located above one another

Example.

Room-separating wall above a room-separating base with an integral room-separating glass element.

Result:

In part, the room-separating effect is revoked.
This causes the room contours to be lost.

Correction:

Here the upper wall and the glass element must not be defined as room-separating.

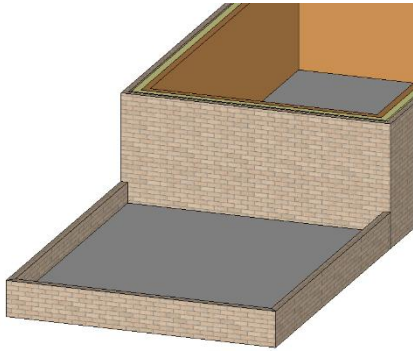

Negative construction area

DIN 277, ÖNORM B

Nettogeschossfläche	NGF	68.39 m ²
Lichte Nettogeschossfläche	NGF	63.26 m ²
Konstruktionsfläche	KF	-16.18 m ²
Geschossfläche	GF	52.21 m ²

1800 or SIA 416 report:

Before evaluation, the model must be refreshed:

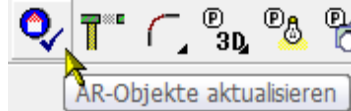

Toolbar *Modify > Refresh AR objects > All objects. Erroneous results may arise if using a non-refreshed model, e.g. negative construction areas.

Similarly, incorrectly-set room separations may be the cause. In the example the terrace is slightly offset from the building and a room separation was incorrectly set around it. Similarly, the parapet is room-separating. The room separation along the parapet must be removed. See [Display room separations](#).

Check 2D model

(Menu Info)

Using this function, the models of the evaluation contours can be checked for open polygons.

Display evaluation rooms

Menu Extras > Evaluation > Display evaluation rooms

Toolbar Evaluation > Display evaluation rooms

The following are displayed:

- Room-separating walls with wall openings (windows, doors).
- Room-separating glass elements
- Columns
- Chimneys
- Room separators

Synonyme	Farben	INI-Werte	Texte	Optionen	Objektarten
Id	Norm	Ge	Objekt	Wertart	Wert
1...	SIA d...	Raum	Fenstermische zur NGF rechnen ...		1
1...	SIA d...	Raum	Minimale Nischentiefe		0.001
1...	SIA d...	Raum	Mindestraumgrösse		1
4...	SIA d...	H...	Dac...	Überlänge ab	8
4...	SIA d...	H...	Dac...	Querschnitts-Grenzwert Volumen...	0.01
6...	SIA d...	Raum	Berechnungsergebnis anzeigen		1

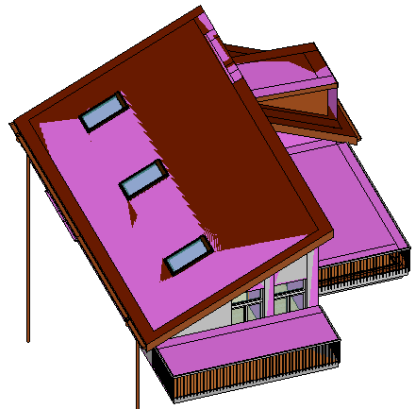
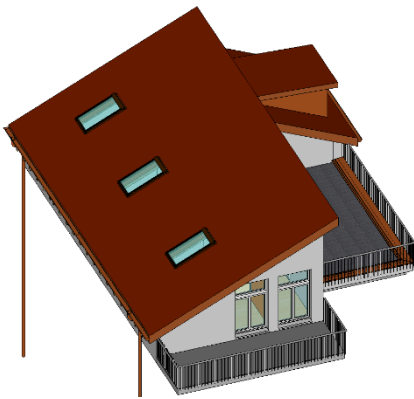

8.2 Expanded control functions

Menu Extras > Evaluation > Quantities manager

Toolbar *Create new AR objects

Toolbar > Evaluation > Quantities manager

In quantities manager: Rules/Configuration button.

In the options list, the option “Display calculation result” is set to 1.

In the evaluation, new 3D objects are created for the “additional CAD layer”: If the option is reset to 0, these objects are deleted for the next evaluation.

Model without additional control layer

Model (German model) with additional control layers:

- Room-limiting areas
- Storey-limiting areas

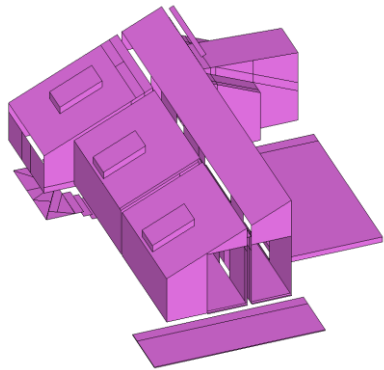

Control layer for room volume

Control layer for room-limiting areas

The net volume of rooms is shown using 3D surfaces. These are only visible in the solid model (illustration) or wireframe model. The surfaces are open for openings.

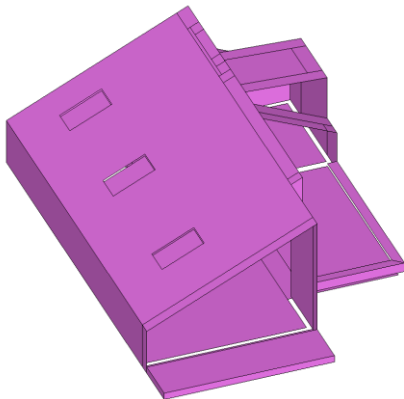

Control layer for storey-limiting areas

The gross room volume of buildings is shown using 3D surfaces. These are only visible in the solid model (illustration) or wireframe model. The surfaces are open for openings.

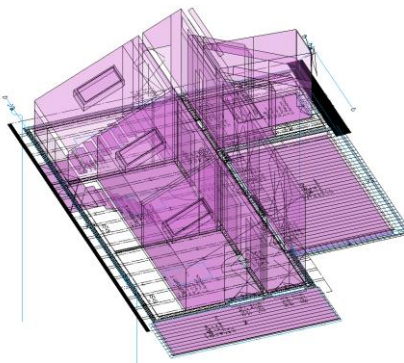

Room box diagram for rooms

By comparison with the room-limiting areas layer, in quantities manager it is possible to switch to room box display from a previous solid model display.

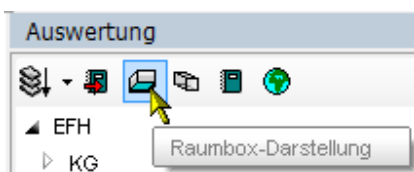

9. Evaluation

9.1 Evaluation in DB



Menu Extras > Evaluation > Evaluation in DB

Toolbar Evaluation > Evaluation in DB

Quantities manager > Evaluation in DB

- Before evaluation, the model must be stripped out using refresh AR objects (only possible in EliteCAD).
- The value settings required for the evaluation are imported before the calculations.
- EliteCAD AR13 + BIM2COST 13: All (including non-displayed) construction parts are evaluated and exported to the MySQL database.
- Docuplan: with the option enabled, the document texts are allocated to the construction parts.
- Per project, several models can be evaluated. The model name (drawing name) is also saved to the database, along with the project name.

9.2 Docuplan

- Docuplan is used to monitor the evaluation.
- The docu-texts are allocated to the evaluated objects.
- Docu-texts are listed in the reports.

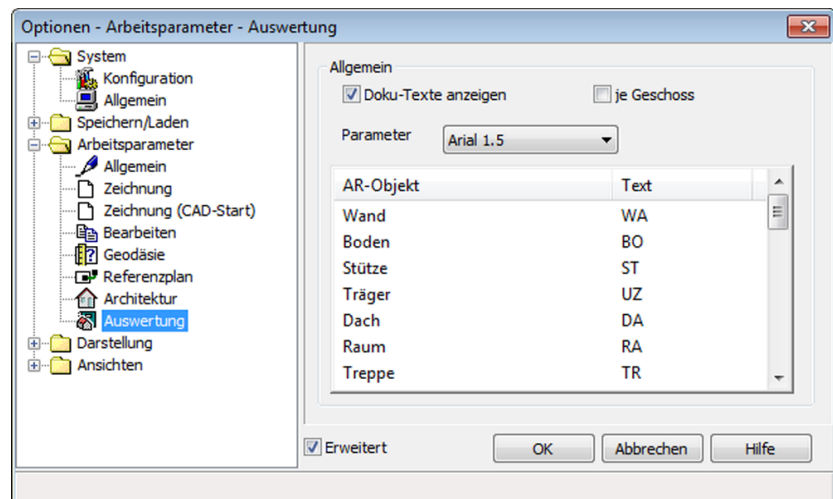

Requirement for displaying docu-texts:

- Work parameter(s) > Evaluation
- Enable "Display docu-texts"
- Select text parameter(s)

The docu-text can be modified in the text column.

The docu-texts are written to the docu-text layer.

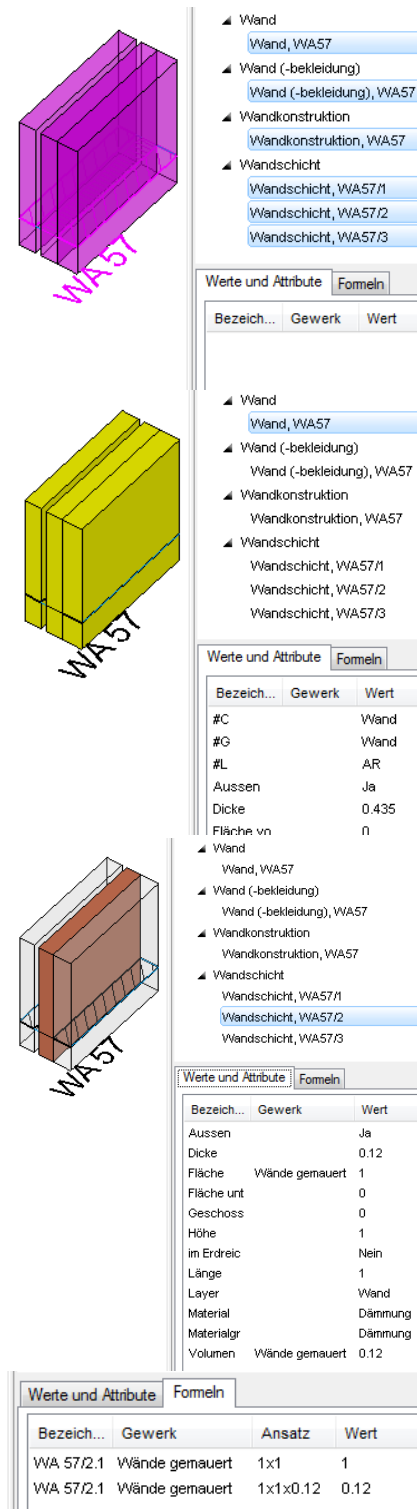

9.3 Object types

In quantities manager, the object types can be selected and viewed in the CAD.

For the object types, the description is supplemented with the docu-text.

CAD object - Object types - Docu-text

CAD object

The CAD object is selected in the CAD.

When to docu-texts option is switched on (see previous chapter), it is assigned a docu-text during evaluation. In the CAD, this is written into the floor plan (WA57).

When a CAD object is selected in the CAD, the quantities manager displays the object types of which the object consists.

In the index of values and attributes, nothing is displayed.

Object types

A detailed listing of all object types is listed in the User Manual.

Main object type

Main object type and CAD object are generally identical, but the main object type is selected in the quantities manager.

In the CAD, the object types are shown in accordance with the [Colour setting for object types](#) (document end).

Some values, e.g. the total thickness (thickness) of this main object type are listed in the “values and attributes” window.

Sub-object types

Layer (e.g. wall layer)

A layer is a sub-object type.

The docu-text is supplement in the quantities manager with the layer number. (WA57/2).

The results are listed for the “values and attributes”. For walls, sometimes this includes the associated trade.

The detailed calculation is listed in the “formulae” index.

The document number is supplemented with the section number. (WA572.1)

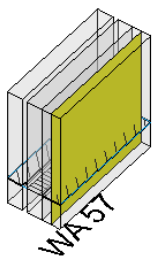

- ▲ Wand
 - Wand, WA57
- ▲ Wand (-bekleidung)
 - Wand (-bekleidung), WA57
- ▲ Wandkonstruktion
 - Wandkonstruktion, WA57
- ▲ Wandschicht
 - Wandschicht, WA57/1
 - Wandschicht, WA57/2
 - Wandschicht, WA57/3

Werte und Attribute		Formeln
Bezeich...	Gewerk	Wert
Aussen		Ja
Bekleidun		Backstein,
Bodenfläc	Wände gemauert	0.15
Dicke	Wände gemauert	0.15
Fläche	Wände gemauert	1
Geschoss		0
im Erdreic		Nein
Länge	Wände gemauert	1
Layer		Wand
Materialinf		Backstein
Max. Höh	Wände gemauert	1
Tragschic	Wände gemauert	0.15

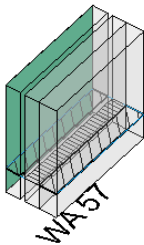

- ▲ Wand
 - Wand, WA57
- ▲ Wand (-bekleidung)
 - Wand (-bekleidung), WA57
- ▲ Wandkonstruktion
 - Wandkonstruktion, WA57
- ▲ Wandschicht
 - Wandschicht, WA57/1
 - Wandschicht, WA57/2
 - Wandschicht, WA57/3

Werte und Attribute		Formeln
Bezeich...	Gewerk	Wert
Aussen		Ja
Bodenfläc	Wände gemauert	0.285
Dicke	Wände gemauert	0.285
Fläche	Wände gemauert	1
Fläche unt		0
Geschoss		0
im Erdreic		Nein
Länge	Wände gemauert	1
Layer		Wand
Materialinf		Backstein,
Max. Höh	Wände gemauert	1

Construction and sublayer (e.g. wall construction)

For multi-layer construction parts, the layers described as “load-bearing” are evaluated as load-bearing.

For instance, for walls the supporting layer is evaluated as wall construction.

For wall constructions, deduction audits for openings are undertaken and shown in the CAD. For a wall opening, the displayed area is crossed through if it is smaller than defined in the options (walls + plaster).

Sublayers of room finishes may comprise several layers (only BIM2COST).

Facing and covering finish (e.g. wall (facing))

For multi-layer construction parts, the layers described as “facing” are evaluated as facing. For room finishes, the visible finishes are evaluated as a covering finish.

Facings, unlike constructions, are measured on the surface. For a wall opening, the displayed area is crossed through if it is smaller than defined in the options (walls + plaster).

Facings may comprise several layers. Multiple layers are possible for covering finishes (only in BIM2COST).

10. Evaluation options and lists

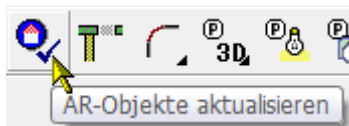
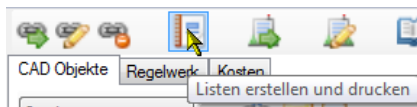

Lists in EliteCAD

Menu Extras > Evaluation > Reports

Toolbar > Evaluation > Create and print lists

Quantities manager > Create and print lists

Lists in BIM2COST

Evaluation management > Create and print lists

General

Requirement

In order that a model can be evaluated correctly, this must first be cleaned up using refresh AR objects.

Evaluation EliteCADAR13

An already-evaluated model (drawing name) does not need to be evaluated again. The evaluation remains stored in the database. If the model is modified, however, a new evaluation is required. Recommendation: New model name, that can be compared with the old model.

Evaluation BIM2COST 13

When a model is first imported, it is evaluated automatically. If this is imported again later, it is checked following modifications to the model and updated in BIM2COST together with the modifications made in the last session.

Properties description and type

For the construction parts lists, the property description and type is output.

Project management

Menu Extras > Evaluation > Project Management

See also User Manual, Chapter 14.1

The projects and associated evaluated models are listed in project management.

Deleting models

Individual models or whole projects can be removed from the database using the delete button.

The reset database button causes all models to be removed from the database.

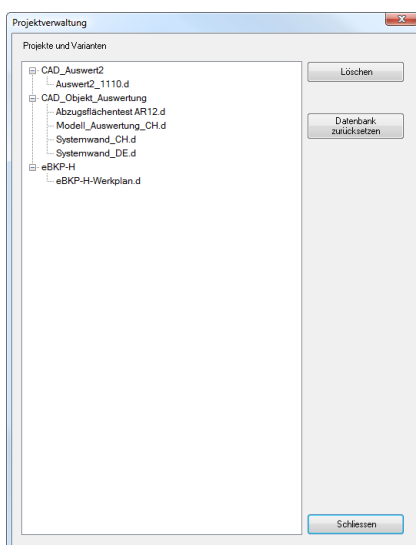

10.1 Print lists

EliteCAD

Menu Extras > Evaluation > Reports

Toolbar > Evaluation > Create and print lists

Quantities manager > Create and print lists

Requirement

In order for the lists overview to be opened, the model must be imported and evaluated in the CAD.

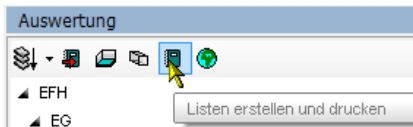

1. Grundmengen	2.2 Fundamente und Decken
1.1 Grundrissflächen und Volumen	2.2.01 Fundamente
1.1.01 Grundflächen und Rauminhalte	2.2.02 Betondecken
1.1.02 Grundflächen und Rauminhalte	2.2.03 Betondächer
1.1.03 Grundflächen und Rauminhalte	2.2.11 Verschiedene Deckenkonstruktionen und Bekleidungen
1.1.04 Grundflächen nach SIA 416	2.2.21 Spezielle Deckenbekleidungen (Typ Raumdecke)
1.1.81 Gebäudevolumen mit Nachv	2.2.91 Alle Deckenschichten
1.1.91 Flächennachweis Rohmasse	2.3 Dächer
1.1.92 Flächennachweis reduzierte Da	2.3.01 Dach Flächen und Kanten
1.2 Wohnflächen (Putzabzug eff.)	2.3.91 Alle Dachsichten
1.2.01 Wohnflächen (Putzabzug eff.)	2.4 Bauteile 2. Teil
1.2.91 Flächennachweis Wohnflächen	2.4.01 Konstruktionsholz
1.6 Fassade	2.4.11 Stützen
1.6.01 Aussenwandflächen	2.4.21 Unterzüge
2. Bauteile 1. Teil	2.4.31 Treppen
2.1 Wände	2.4.41 Kamine
2.1.01 Wände gemauert nach Gescho	2.4.51 Kanalisation
2.1.02 Wände gemauert nach Material	2.4.61 Geländer
2.1.04 Wände betoniert nach Gescho	2.4.71 Freie Objekte
2.1.05 Wände betoniert nach Material	3. Öffnungen
2.1.11 Wände Trockenbau nach Gescho	3.1 Fensterliste
2.1.12 Wände Trockenbau nach Material	3.2 Fensterliste mit Bildern
2.1.13 Montagewände Trockenbau nach Gescho	3.3 Türliste
2.1.14 Montagewände Trockenbau nach Material	3.4 Türliste mit Bildern
2.1.21 Aussendämmung nach Gescho	3.5 Fensterbänke
2.1.22 Aussendämmung nach Material	3.6 Fenstersimse
2.1.31 Übrige Aussenwände nach Gescho	4. Räume
2.1.32 Übrige Aussenwände nach Material	4.1 Bodenbeläge
2.1.41 Äussere Montagewände nach Gescho	4.1.1 Bodenbeläge nach Einheit
2.1.42 Äussere Montagewände nach Material	4.1.2 Bodenbeläge nach Einheit (Summen)
2.1.51 Übrige Innenwände nach Gescho	4.1.3 Bodenbeläge nach Material
2.1.52 Übrige Innenwände nach Material	4.1.4 Alle Bodenbelagsschichten nach Material
2.1.61 Übrige innere Montagewände nach Gescho	4.2 Wandbeläge
2.1.62 Übrige innere Montagewände nach Material	4.2.1 Wandbeläge nach Einheit
2.1.91 Alle Wandschichten nach Gescho	4.2.2 Wandbeläge nach Einheit (Summen)
2.1.92 Alle Wandschichten nach Material	4.2.3 Wandbeläge nach Material
	4.3.4 Alle Deckenbelagsschichten nach Material
	4.4 Raumblatt-Liste
	4.5 Einrichtungen nach Raum
	6. CAD-Objekte
	6.1 CAD-Objekte
	6.6 Synonyme

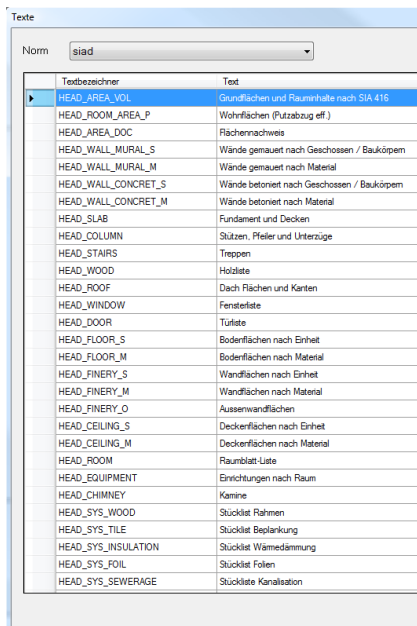
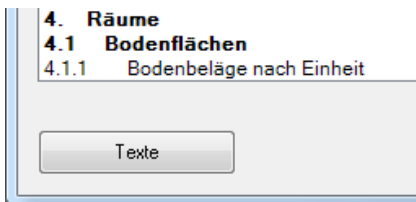
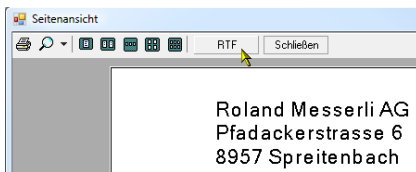

Stammdaten			
Synonyme	Farben	INI-Werte	Texte
Id	Gruppe	Name	Wert
1	Text	Firma	Roland Messerli AG
2	Text	Strasse	Pfadackerstrasse 6
3	Text	Ort	8957 Spreitenbach
4	Text	Telefon	Tel 056 418 38 00
5	Text	Fax	Fax 056 418 39 00
6	Text	Mail	info@rmi.ch
7	Allg	FontSize	10.25

Change options

List in RTF format

After the list has been opened, it can also be saved in RTF format using the RTF button, so that the list can then be edited in a text processing program (e.g. Word).

Text changes

Using the texts button in the lists overview window, the texts used in the lists can be altered.

The text variable (text descriptor) is in the left column.

The text for this variable can be amended in the right column.

List header / company name

The text for the company letterhead is set using the master data for the INI values.

INI values

For the INI values, the company data for [List print-outs](#) is entered.

For Id 7, the font size in the master data window is modified.

10.2 List content

1.1 Areas and volumes

1.101 Areas and room volumes in accordance with DIN 277 (2005 edition), ÖNORM B1800 and SIA 416.

Room list

Note

In order that the lists can be printed out to comply with the standards, the use types and areas must be input for the room definitions in accordance with the current standards DIN 277, ÖNORM B1800 and SIA 416. See [Entries in room definition](#). The room definitions for stairs must always be set in the upper storey. See [Area types for stairs](#)

- Rough and net areas, room volume.
- Totalling of rooms by use types.
Germany + Austria: Totalling of rooms by areas.
- Rooms with non-defined areas (a, b or c) are allocated to Area a for standards DIN 277 and ÖNORM B1800 (covered and enclosed on all sides)
- [Manual perimeter contours](#) for external areas (CH: ANF, AVF, AFF; DE + AT: Areas b + c) take precedence over information in the room definition.
- [Air spaces](#) have no surfaces, but do have room volume.
- Cavities defined using the room description as [construction areas](#) are not listed, but are added to the construction area.
- Rooms for stairs must always be defined as a “normal room” in the upper storey.
- Unlabelled rooms are not listed and are calculated as part of the construction area.

1.1.02 Areas and room volumes in accordance with DIN 277 (2005 edition), ÖNORM B1800 and SIA 416 (totals list).

Totals list

The construction areas are calculated from the difference between the storey areas and the room areas.

SIA 416

- Totals of all standard use types

ÖNORM B1800 + DIN 277

- Totals of areas and room volumes by Areas a, b and c

1.1.91 Plane(s) verification rough dimensions

- Rough part areas with detailed calculation
- The plane(s) verification list is also created without a previous verification.

1.2.01 Living spaces with measured deduction for plaster (woFIV)

- Rough and net areas.
- Evaluation as living space, taking account of reduction factors for low room heights in accordance with WoFIV.
- The set values ([Options room](#)) for limit heights are taken into account during evaluation.
- Window niches are taken into account in accordance with [Options room](#) if the set value is greater than 0. (Germany - Living Space Ordinance (WoFIV) 0.13m)
- The living space percentage is read from the room description.
- Rooms where the living space percentage field was not defined are evaluated using the living space percentage 100%.
- Rooms without room definitions are not evaluated.

1.2.91 Living space verification of areas

- Net part areas with detailed calculation, broken down by limit heights
- The living space verification list is similarly created without a previous graphical living space verification.

1.6 Facade

1.6.01 External wall areas

- Object type external surface without deduction audit

2. Framing

2.1 Walls

Trade /work type

In order for the allocation to a trade or work type is made correctly, the [options](#) and materials for walls must be set.

Breakdown, measurement type

- Breakdown using the layer types wall construction, non load-bearing wall construction, wall facing subconstruction and wall facing
- Layers in the same layer type are measured together in some cases.
- Wall facings are measured on the surface.
- The other layer types are measured using the middle of the layers.

2.1.01 Brick walls by storeys/structures

- Deduction audit in accordance with the options setting. See [Brick walls and wall layers](#).
- Materials in accordance with the options setting. See [Materials for brick walls](#).
- The deduction limit values can be modified.
After this, a fresh evaluation must be performed, and a check is made as to whether an opening is being over-measured and the extent of the over-measurement.
- The walls are output both as a capacity measure and as a surface measure. The deduction audit is performed separately.
- The area measurement is taken in the middle of the wall.
- For multi-layer walls, the layers are listed separately by material. Wall layers which according to the material name do not belong to the brick wall trade are listed in the other lists.
- All layers have a docu-number and can be visualized in quantities manager by selecting them.
The docu-number starts with the docu-text WA, the wall number, and ends with the layer number and the section number, e.g. WA 1/1.1.

2.1.02 Brick walls by material

2.1.04 Concrete walls by storeys/structures

- Deduction audit in accordance with the options setting. See [Concrete walls](#).
- Materials in accordance with the options setting. See [Materials for concrete walls](#).
- Remainder as for brick walls (see above).

2.1.05 Concrete walls by material

2.1.11 Drywall construction walls by storeys/structures

(Plaster walls)

- For multi-layer walls, the object type wall (wall facing) is measured in total with all wall layers. The area is measured on the wall axis side.
- Deduction audit in accordance with the options setting. See [Walls drywall construction \(plaster walls, drywalls\)](#).
- Materials in accordance with the options setting. See [Materials for drywall construction walls](#).

2.1.12 Drywall construction walls by material**2.1.13 System-built walls drywall construction by storeys**

- Partition walls should be defined as a system-built wall. Then all layers are summarized and measured on the surface of the wall

2.1.14 System-built walls drywall construction by type**2.1.21 External insulation by storeys**

Composite thermal insulation system
(Wärmedämmverbundsystem, WDVS)

- All wall layers for external insulation must be defined as facing. The object type wall (wall facing) is measured with all wall layers on the external side.
- Deduction audit in accordance with the options setting. See [External insulation](#).
- Materials in accordance with the options setting. See [Materials for external insulation](#).

2.1.22 External insulation by material**2.1.31 Other external walls by storeys**

- All wall layers that are not allocated to a trade or work type are listed here.
- A deduction audit following the setting for brick walls occurs only if the materials are listed in the options for [Different wall materials](#).

2.1.32 Other external walls by material**2.1.41 External system-built walls by storeys/structures**

- Walls pre-fabrication. Walls must be defined as a system-built wall. Then all layers are summarized and measured on the surface of the wall

2.1.41 External system-built walls by type

2.1.51 Other internal walls by type**2.1.52 Other internal walls by storeys/material****2.1.53 Other internal walls by material****2.1.61 Other internal system-built walls by storeys/structures**

- Walls pre-fabrication. Walls must be defined as a system-built wall. Then all layers are summarized and measured on the surface of the wall

2.1.61 Other internal system-built walls by type**2.1.91 All wall layers by storeys/structures**

- No grouping by layer types
- Each layer is calculated separately

2.1.91 All wall layers by material**2.2 Foundations and slabs*****Breakdown, measurement type***

- Breakdown by layer types floor construction, insulation (non load-bearing), floor sub-construction/dead floor and floor facing
- Layers in the same layer type are measured together in some cases.
- The layer types are measured on the upper surface
- The bottom layer type is measured on the lower surface

2.2.01 Foundations

- Surfaces and volume with calculation verification.

2.2.02 Concrete slabs

- Surfaces and volume with calculation verification.
- There is automatic allocation to the trade or work type concrete slabs if the materials are listed for the wall layer types in situ concrete construction. See also [Trades \(work types\)](#).

2.2.03 Concrete roofs

- CAD slabs defined as a roof and belonging to the trade concrete slabs

2.2.03 Various slab constructions and facings

- CAD slabs which are not allocated to the trade or work type concrete slabs.
- Dead floors
- Slab facings using the CAD slab function
- Slab facing subconstruction

2.2.21 Special slab facings (hollow ceiling type)

- Facings and subconstructions created using the CAD slab function type hollow ceiling

2.2.91 All ceiling layers

- No grouping by layer types
- Each layer is calculated separately

2.3 Roofs***Breakdown, measurement type***

- Breakdown by layer types roof construction, roof insulation (non load-bearing), roof subconstruction, roof skin and soffit
- Layers in the same layer type are measured together in some cases.
- The layer types are measured on the upper surface
- The bottom layer type for the facing type is measured on the lower surface as a soffit.

2.3.01 Roof planes and edges

- Roof planes in true area measurement and roof pitch.
- All roof edges and roof cut-outs in linear measure.
- Listing by material
- CAD roofs and CAD slabs which are defined as roof and not allocated to the trade or work type concrete slabs are listed.

2.3.91 All roof layers

- No grouping by layer types
- Each layer is calculated separately

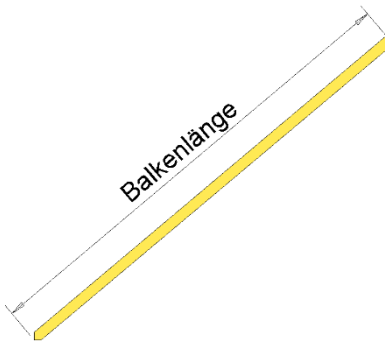

2.4 Construction parts 2nd section

2.4.01 Construction timber

- Cross-sections, length, surfaces and volume.
- The linear measure for all beams corresponds to the beam length before the beam ends have been worked.
- Switzerland:
Cross-sections under 100 cm² in the linear measure in accordance with the limit value setting [Options construction timber](#)
Cross-sections over 100 cm² in capacity measure
Switzerland: Over-lengths (8 m) in accordance with setting [Options construction timber](#)

2.4.11 Columns

- Cross-section shape
- Linear and volume measure

2.4.21 Girders

- Girders with the CAD function girder and with the CAD function wall, type girder.
- Cross-section shape
- Linear and volume measure

2.4.31 Stairs

Stairs are listed grouped by type.

The evaluation covers:

- The listing, separated by material or by the main material: If the stairs have a flight plate, this material takes precedence. Secondly, the material for the cheek is used, and if no stair cheek is present either, then the material for the step is definitive for the stair material.
- Steps: Number, slope, edge length, covering thickness and tread area
- Entrances and exits. The volume is already calculated in the stair runs.
- Cheeks: Length horizontal and diagonal
- Stair flight plates: Slope, width, depth, height, length, area on the underside, and volume
- Landings: Width, length, depth, area, volume, covering thickness, cheek length and area on the underside.

2.4.41 Chimneys

- Materials, shape and height

2.4.51 Drainage

Only the drainage created using the drainage module is listed.

- The listing is separated by pipes and the shaped parts by the material
- Listing for shafts

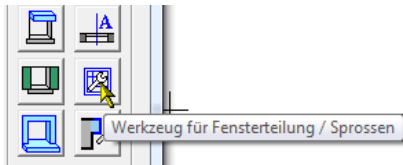

2.4.61 Banisters

2.4.71 Free objects

- 3D objects defined using the function [Define 3d objects as construction part](#), type "Free Object".

3. Openings

3.1 Windows list

- Windows and glass elements
- Width, height and area for architectural lighting and frames
- Germany + Austria: grouped by frame size
- Switzerland: grouped by architectural lighting.
- Parapet height, shape and opening type
- For window combinations with several sections, the opening types are listed separately, separated by commas.
- Material and roller shutter box/gallery
- Room allocation
- Windows which are not allocated to any room are listed without an indication of room.

3.2 Windows list with images

- In addition to the normal windows list, the window graphic is created.
- The opening type is only displayed if this is set in the window parameter > Tool for window settings / muntins > Opening symbol.
- When this list is initially selected, the graphics are calculated (this therefore takes a certain time).

3.3 Doors

- Frame aperture and wall aperture
- Doors: Door type, material, thickness, hinge side and fire protection class.
- Wall thickness and room allocation (door hinge side or door opened)
- Doors to external rooms are always allocated to the internal room.

3.4 Door list with images

- In addition to the normal doors list, the graphic of the floor plan is created.
- When this list is initially selected, the graphics are calculated (this therefore takes a certain time).

3.5 Windowsills, external

- External windowsills created with the window

3.6 Windowsills, internal (ledges)

- Internal windowsills (ledges) created with the window.

4. Rooms

Breakdown, measurement type for room finishes

- Breakdown by layer types covering finish and covering finish subconstruction. In the floors list, the Swiss specialist term “Unterlagsboden” (subfloor) is used for the subconstruction. The subfloor contains all layers in the subconstruction (screeds, insulation, etc.)
- Layers in the same layer type are measured together in some cases.
- The layer types are measured on the upper surface
- Subconstructions can be created for wall and ceiling finishes only in BIM2COST

4.1 Floor finishes

4.1.1 Floor finishes by unit

- Sorting and totalling by unit (apartment), where the unit field is not empty in the room description. Rooms for units may be distributed in the same structure over several storeys.
- Rooms defined as air space or construction area are not listed.
- Areas with calculation formulae, for stairs for steps and landings. See also [Area types for runs of stairs and landings](#) and [Floor covering finishes for stairs](#)
- Areas separated by material. In later versions, with scope.

4.1.2 Floor finishes by unit (totals list)

- Room listing per unit

4.1.3 Floor finishes by material

4.1.4 All floor finish layers

- No grouping by layer types
- Each layer is calculated separately

4.2 Wall finishes

4.2.1 Wall finishes by unit

- Sorting and totalling by unit (apartment), where the unit field is not empty in the room description.
Rooms for units may be distributed in the same structure over several storeys.
- Rooms defined as construction area are not listed.
- The height is measured between the lower edge of the floor to the maximum room height.
- The reduction on the roof through offset for insulation and the depth of the insulation is taken into account.
- Calculation and deduction audit for areas in accordance with [Options wall finish](#). For wall finishes on stairs, see also [Area types for runs of stairs and landings](#) and [Wall finishes for stairs](#)
- Listing, sorted by base for the finish and material

4.2.2 Wall finishes by unit (totals list)

- Room listing per unit

4.2.3 Wall finishes by material

4.2.4 All wall finish layers by material

- No grouping by layer types
- Each layer is calculated separately

4.3 Slab finishes

Note

EliteCAD calculates the slab finishes for slabs at the storey and level floor of the storey located above, taking account of their height and shape (e.g. slab openings). For that reason, all storeys must be loaded for the evaluation. If no above storey is present, then the slab finishes are calculated in accordance with the room contour.

Slab finishes are similarly calculated on the underside of roofs and stairs.

4.3.1 Slab finishes by unit

- Sorting and totalling by unit (apartment), where the unit field is not empty in the room description.
Rooms for units may be distributed in the same structure over several storeys.
- Rooms defined as construction area are not listed.
- Slab finishes are calculated on the underside of storey and level floors above them, roofs and stairs.
- Areas with calculation formulae, for stairs the measured area on the underside of the stairs. See also [Area types for runs of stairs and landings](#) and [Slab finishes for stairs](#)
- Slab finishes below pitched roofs use the measured area.
- The reduction on the roof through offset for insulation and the depth of the insulation is taken into account. See also [Roof](#).
- Rooms defined as construction area are not listed.
- Area and material.

4.3.2 Slab finishes by unit (totals list)

- Room listing per unit

4.3.3 Slab finishes by material

4.3.4 All slab finish layers by material

- No grouping by layer types
- Each layer is calculated separately

4.4 Room sheet list

- Room surfaces with material
- Room area, room volume, marker, minimum and maximum room height.
- Area type, use type and area (NF, etc.) (a,b,c)
- Windows and doors, with size
- Rooms without room descriptions and rooms defined as construction area are not listed.

4.5 Installation list

Listing per room of defined [Installations](#).

Lists in BIM2COST

In BIM2COST, in each case the constructed model is exported to the lists.



Create and print lists

Additional lists:

5. Costs

As per element method eBKP-H

6. CAD objects

Lists by various criteria

Double-clicking on the text of the list title opens that list.

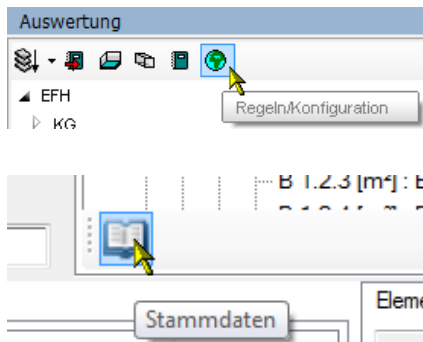

10.3 Value settings

Value settings in EliteCAD

Quantities manager > Rules/Configuration

Value settings in BIM2COST

Evaluation management > Index of regulations > Master data

Countries and regions settings

The MySQL database is constructed in such a manner that, depending on the Windows settings (System management > Region and language options), the region-specific settings and materials are used for the evaluation.

For Switzerland, the materials are recorded from the materials parameters collection and from the NPK lists of standardized items.

For Austria, the materials from LB-HB (Leistungsbeschreibung - Hochbau, definitions of building construction services) are recorded.

For Germany, the materials from various German documents are recorded.

Spelling:

When allocating to overarching terms, the precise entry for the name of the material is compared. Lower case is not replaced with upper case.

The beta-shaped double-s character "ß" used in Austria and Germany is not viewed as the same as the combination "ss".

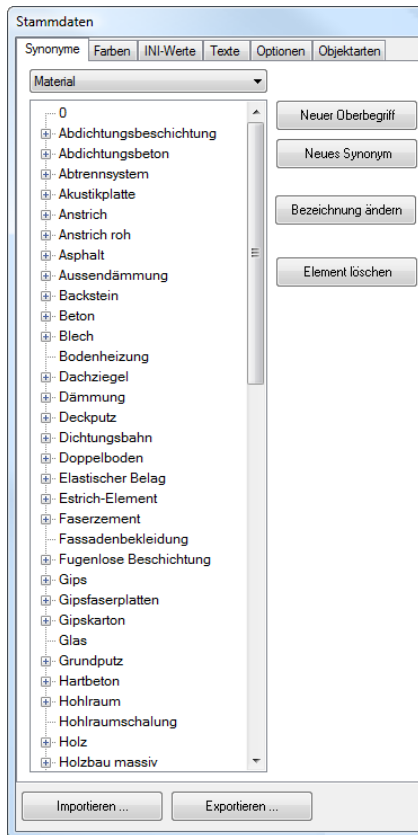

Synonyms

General

Material

The overarching terms and synonyms for materials are recorded in the synonyms index (see illustration).

The overarching terms are used in the rules.

Name

For the “Material” button, it is possible to switch to names. The room names are recorded there (for BIM2COST).

EliteCAD

Rules

The allocation to the work type or trade is controlled via the overarching terms for materials. Only the overarching term is recorded in the allocation rule. For an example, see [Materials for brick walls](#).

Synonyms

To avoid every individual material needing to be recorded in the rules, they are recorded as synonyms linking to the overarching term.

BIM2COST

Rules

The allocation to the cost element is controlled via the overarching terms for materials.

The allocation to the cost element is controlled via the overarching terms for names (room name).

Synonyms

To avoid every individual material needing to be recorded in the rules, they are recorded as synonyms linking to the overarching term.

The same applies to names for the room name ‘kitchen’.

OPTIONS

Synonyme Farben INI-Werte Texte Optionen Objektarten					
Id	Norm	Gewerk	Objektart	Wertart	Wert
51	SIA deutsch			Ergebnis aus Formel	1
49	SIA deutsch			Formelgenauigkeit	3
48	SIA deutsch			Wertgenauigkeit	4
50	SIA deutsch			Winkelgenauigkeit	1
450	SIA deutsch	Holztragkonstruktion	Dachstuhl	Querschnitts-Grenzwert Volumen-/Längenmass (m³)	0.01
448	SIA deutsch	Holztragkonstruktion	Dachstuhl	Überlänge ab	8
675	SIA deutsch		Raum	Berechnungsergebnis anzeigen	0
47	SIA deutsch		Raum	Faktor über Grenzhöhe 2	1
45	SIA deutsch		Raum	Faktor unter Grenzhöhe 1	0
46	SIA deutsch		Raum	Faktor zwischen Grenzhöhen	0.5
193	SIA deutsch		Raum	Fenstermische zur NGF rechnen 1/0 (ja/nein)	1
173	SIA deutsch		Raum	Mindestraumgrösse	1
183	SIA deutsch		Raum	Minimale Nischentiefe	0.001
42	SIA deutsch		Raum	Wohnflächen, Grenzhöhe 1	1
43	SIA deutsch		Raum	Wohnflächen, Grenzhöhe 2	2
366	SIA deutsch	Aussendämmung	Wand (-bekleidung)	Wände in m², übermessene Öffnungen bis inkl.	1
298	SIA deutsch	Trockenwand	Wand (-bekleidung)	Wände in m², übermessene Öffnungen bis inkl.	1
268	SIA deutsch	Wände betoniert	Wand (-bekleidung)	Wände in m², übermessene Öffnungen bis inkl.	2
269	SIA deutsch	Wände betoniert	Wand (-bekleidung)	Wände in m², übermessene Öffnungen bis inkl.	0.1
35	SIA deutsch	Wände gemauert	Wand (-bekleidung)	Wände in m², übermessene Öffnungen bis inkl.	1
37	SIA deutsch	Putze	Wandbelagschicht	Oberfläche m², übermessene Öffnungen bis inkl.	0.5

Objektart	Wertart	Wert
	Ergebnis aus Formel	1
	Formelgenauigkeit	3
	Wertgenauigkeit	4
	Winkelgenauigkeit	1

General options

Result of the formula (not yet implemented)

Calculation result from formulae or value from measurement

Accuracy of the formula

Number of decimal places to be displayed. Internally, calculations are made using one additional decimal place.

Accuracy of values

Number of decimal places

Accuracy of angles

Number of decimal places

Objektart	Wertart	Wert
Raum	Berechnungsergebnis anzeigen	0
Raum	Faktor über Grenzhöhe 2	1
Raum	Faktor unter Grenzhöhe 1	0
Raum	Faktor zwischen Grenzhöhen	0.5
Raum	Fensterische zur NGF rechnen 1/0 (ja/nein)	1
Raum	Mindestraumgröße	1
Raum	Minimale Nischentiefe	0.001
Raum	Wohnflächen, Grenzhöhe 1	1
Raum	Wohnflächen, Grenzhöhe 2	2

Options room

Display calculation result

See [Height monitoring function](#)

Factor above limit height 2

for living space calculations. Factor above upper limit height

Factor above limit height 1

for living space calculations. Factor under lower limit height

Factor between limit heights

for living space calculations. Factor between limit heights

Calculate window niche as NGF

for areas in accordance with SIA 416, DIN 277 and ÖNORM B1800

Minimum room size (not yet implemented)

for areas in accordance with SIA 416, DIN 277 and ÖNORM B1800

Smaller rooms are not calculated as spaces.

Minimum niche depth

for living space calculations.

Value 0 means that window niches are not calculated.

For Germany, this must be set in accordance with WoFIV as 0.13.

For niches to be calculated, this must be set to a minimum value, e.g.0.001.

Living spaces, limit height 1

Lower limit height above upper edge of the finished floor for living space calculations.

Living spaces, limit height 2

Upper limit height above upper edge of the finished floor for living space calculations.

Options walls

The deduction audits for openings apply for all object types for walls (wall layer, wall (wall facing), wall construction)

For wall (wall facing) and wall construction, the overmeasured openings are displayed with a continuous visualization plane.

Trades are managed using materials and synonyms.

EliteCAD

With deduction audits

BIM2COST

In BIM2COST, all calculations are performed using the measured dimensions (no deduction audits)

Brick walls and wall layers

Trade (work type): Brick walls

Openings deduction audit for masonry using area measurement.

Materials for brick walls

Only the materials and their synonyms included in the index

Object types > Masonry is listed.

The materials list can be modified.

The material insulation must, under some circumstances, be adapted for the particular circumstances (and possibly deleted).

The name of the insulation must be different from the materials for external insulation layers and plaster walls.

arbeiten INI-Werte Texte Optionen Objektarten			
Gewerk	Objektart	Wertart	Wert
Wände gemauert	Wand...	Wände in m ² , übermessene Öffnungen...	1

Synonyme Farben INI-Werte Texte Optionen Objektarten	
Wandschichttypen	
Ortbetonbau Mauerwerk Gipswände Aussendämmschichten	
Nr	Synonym
1000...	Backstein
1000...	Kalksandstein
1000...	Kaminstein
1000...	Sichtmauerwerk
1000...	Plattenmauerwerk
1000...	Zementstein
1000...	Porenbeton
1000...	Dämmung

Synonyme Farben INI-Werte Texte Opti

Material

- [-] Backstein
 - ... bn
 - ... bns
 - ... Calmo
 - ... Hohlblockziegel
 - ... Leichtbackstein
 - ... Leicht-Backstein
 - ... Leicht-Backstein MBL
 - ... Leicht-Backstein MBLD
 - ... MB
 - ... MBD
 - ... MBL
 - ... MBLD
 - ... Verbandmauerwerk Backstein
 - ... Ziegelstein

Synonyms

Example brick (Backstein, CH) left, brick (Ziegelstein, DE+AT) centre + right

<ul style="list-style-type: none"> [-] Ziegel <ul style="list-style-type: none"> ... Blockziegel ... BLZ ... HLZ ... HLzB ... HLz-Block ... HLz-Plan ... Hochlochziegel ... Keller-PLZ ... Leichthochlochziegel ... LHLzW ... MZ ... PFZ ... Planfüllziegel ... Planziegel ... PLZ ... Poroton ... Schallschutzziegel ... Ziegel_HLZ ... Ziegelstein ... ZWP ... ZWP-Plan-T 	<ul style="list-style-type: none"> [-] Ziegel <ul style="list-style-type: none"> ... Calmo ... HLZ ... HLZ-Mwk ... HLZ-Mwk.Schallschutz ... HLZ-Mwk.Wärmeschutz ... HLZ-Plan ... HLZ-Plan-Mwk ... hochlochz ... Hochlochziegel ... Hohlblockziegel ... keram.Ziegel ... Mauerziegel ... NF Ziegel ... Planziegel ... Porotherm ... POROTHERM ... POROTHERM SBZ.i Plan ... Rollierung ... Verbandmauerwerk Backstein ... Verfüllziegel ... ziegel ... Ziegel_HLZ ... Ziegel_HLZ_WD ... Ziegel_NF ... Zw-NF Ziegel-Mwk.
--	--

Wände betoniert	Wand ...	Wände in m², übermessene Öffnungen...	2
Wände betoniert	Wand ...	Wände in m², übermessene Öffnungen...	0,1

Synonyme Farben INI-Werte Texte Optionen Objektarten

Wandschichttypen

Ortbetonbau	Mauerwerk	Gipswände	Aussendämmschichten
Nr	Synonym		
1000...	Beton		
1000...	Abdichtungsbeton		

Synonyme Farben INI-Werte

Material

- Beton
 - Eisenbeton
 - LB1
 - Leichtbeton
 - Magerbeton
 - NPK A
 - NPK B
 - NPK C
 - NPK D
 - NPK E
 - NPK F
 - NPK G
 - Recyclingbeton
 - Recycling-Beton
 - Sichtbeton
 - Stahlbeton
 - Waschbeton
- Beton C50/60
- Beton C55/67
- Beton C60/75
- Beton C70/85
- Beton C8/10
- Beton C80/95
- Beton C90/105
- Beton_LB_WD
- Beton_STB
- Eisenbeton
- Leichtbeton
- Magerbeton
- Recyclingbeton
- Recycling-Beton
- Sichtbeton
- stahlbeton
- Stahlbeton
- Waschbeton

Concrete walls

Trade (work type): Concrete walls
 Openings deduction audit for concrete wall using volume and area measurement (only EliteCAD)

Materials for concrete walls

Only the materials and their synonyms included in the index
 Object types > Masonry is listed.

Synonyms

Example concrete (CH) left and DE + AT right

Trockenwand	Wand ...	Wände in m², übermessene Öffnungen...	1
-------------	----------	---------------------------------------	---

Synonyme	Farben	INI-Werte	Texte	Optionen	Objektarten
----------	--------	-----------	-------	----------	-------------

Wandschichttypen	
Ortbetonbau	
Mauerwerk	
Gipswände	
Aussendämmschichten	
Nr	Synonym
1000...	Gips
1000...	Gipskarton
1000...	Gipsfaserplatten
1000...	Ständerwand
1000...	Trockenbaudämmung
1000...	Plattenwand

Walls drywall construction (plaster walls, drywalls)

Trade (work type): Walls in drywall construction

Openings deduction audit for drywall construction walls using area measurement (only EliteCAD)

Materials for drywall construction walls

Only the materials and their synonyms included in the index Object types > Plaster walls are listed.

The name of the material used to insulate partition walls and facings in plaster must be different from the names for external insulating layers and insulation for brick walls. Here the term drywall insulation was used.

arbeiten	INI-Werte	Texte	Optionen	Objektarten
Gewerk	Objektart	Wertart		Wert
Aussendämmung	Wand ...	Wände in m², übermessene Öffnungen...		1

Wandschichttypen	
Ortbetonbau	Mauerwerk
Gipswände	Aussendämmschichten
Nr	Synonym
100017	Aussendämmung

Synonyme	Farben	INI-Werte	Texte	Optionen	Objektarten
Wandschichttypen					
Ortbetonbau	Mauerwerk	Gipswände	Aussendämmschichten	Übrige Schichten	
Nr	Synonym				
1000...	Holz				
1000...	Holzverkleidung				
1000...	Holzwerkstoff				
1000...	Naturstein				
1000...	Kunststein				
1000...	Vorfabrikation in Beton + künstl. Steinen				

External insulation

Trade (work type) external insulation

Openings deduction audit for external insulation using area measurement (only EliteCAD)

Miscellaneous wall materials

No trade (work type)

All layers are listed separately.

The materials listed for wall layer types under “Other layers” are listed with a deduction audit (in accordance with the set values for brick walls), and the others without a deduction audit.

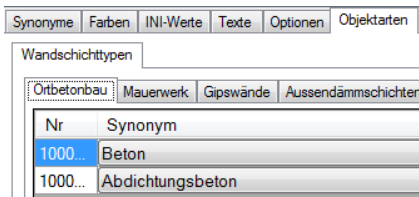

Options CAD floors (slabs etc.)

Trades (work types):

The materials included under Object types > Wall layer types > In-situ concrete construction are valid for drawn CAD floors and CAD roofs. Trade concrete slabs.

No trade is allocated to CAD floors and CAD roofs in other materials.

Concrete foundations and slabs

In the lists, lists are divided in accordance with the definitions given for CAD slabs, by:

- Single foundations
- Strip foundations
- Foundation slab
- Slabs (external and internal slab)

CAD slabs with the definition roof are specially designed for users working with the Swiss cost estimation type eBKP-H and with BIM2COST.

Under eBKP-H, slabs situated under external spaces or under the outer shell of the building must be defined as roof.

If these slabs are to appear in the list of foundations and slabs, this must not be defined as roof. In BIM2COST, it can subsequently be defined as roof.

Synonyme		Farben	INI-Werte	Texte	Optionen	Objektarten	Wandbelagsdicke
Nr	Synonym						Putzstärke
3000	Gips						0
3000...	Gipskarton						0
3000...	Gipsfaserplatten						0
3000...	Beton						1
3000...	Backstein						2
3000...	Kalksandstein						1.5
3000...	Ständerwand						0
3000...	Plattenmauerwerk						2
3000...	Sichtmauerwerk						0
3000...	Plattenwand						0
3000...	Kabinentrennwand						0
3000...	Porenbeton						1
3000...	Holz						0
3000...	Holzverkleidung						0
3000...	Holzwerkstoff						0
3000...	Glas						0
3000...	Holzwerkstoff						0
3000...	Metall						0
3000...	Kunststein						0
3000...	Naturstein						0
3000...	Trennwand						0
3000...	Trennwand beweglich						0
3000...	Zementstein						1.5

Wall finish thickness depending on the base

New feature for EliteCAD AR13 R3

In the wall finish thickness index, the standard thickness of the wall finish is set for various bases.

This means that differences in covering depth can be taken into account, including for the calculation of living space areas.

The base materials (wall materials) are listed, selected from the listing in the [Synonyms](#) index.

The covering depth (plaster depth column) is entered depending on the CAD setting (m, cm, mm etc.)

The Add and Remove buttons can be used to modify the list.

Stammdaten

Synonyme | Farben | INI-Werte | Texte | Optionen | Objektarten

Attribute	Attributwerte	Objektarten	Wertarten	Gewerke
Id	Name	Beschreibung		
0	kein	kein		
1	Einheit	Wohnung / Büro		
2	Flächentyp (air=Luftraum)	Flächen-Bereich		
3	Beschreibung	Beschreibung		
4	Querschnitt	Querschnitt		
5	Feuerwiderstandsklasse	Feuerwiderstanc		
6	Formteil	Formteil		
7	Form	Form		
8	Aussen	Aussen		
9	Schicht	Schicht		
10	Zargentyp	Türrahmenart		
11	Material	Material		
12	Name	Name		
13	Öffnungsarten	Öffnungsarten be		
14	Dachbereich	Dachbereich z.B		
15	Raumnummer	Raumnummer		
16	Abschnitt	Gruppierung vor		
17	Treppentyp	z.B. Wendeltrepp		
18	Treppenbereich	z.B Antritt		
19	Türblatt	Türblatt		
20	Typ	Typ		
21	Einheit	Masseinheit		
22	Flächengliederung NGF	Flächengliederu		
23	Zone	Zone		
25	Teil	Teil		
26	Untergrundmaterial	Untergrundmate		

Importieren ... Exportieren ...

Text changes

In the texts index, all texts displaying in the quantities manager can be modified.

Stammdaten

Synonyme | Farben | INI-Werte | Texte | Optionen | Objektarten

Id	Name	Stift	Farbe
37	Wand (-bekleidung)	752	
0	Nicht definiert	398	
1	Fläche	6	
2	Deckenbelag	6	
3	Kamin	6	
4	Stütze, Pfeiler	349	
5	Türe	391	
6	Einrichtung	811	
7	Abwasserrohre	349	
8	Kanalisationsstrang	792	
9	Decke	67	
10	Balkenkonstruktion	150	
11	Bodenbelag	6	
12	Bodenbekleidung	6	
13	Folie	6	
14	Freies Objekt	6	
15	Untersatz	6	
16	Isolation	6	
17	Öffnung	6	
18	Glaskonstruktion	25	
19	Geländer	349	
20	Dach	349	
21	Dachkonstruktion	358	
22	Dachhaut	349	
23	Dachstuhl	67	
24	Konstruktionsholz	67	
25	Raum	6	
26	Dauertüren	6	

Importieren ... Exportieren ...

Colour setting for object types

In the colours index, the colours for displaying object types can be modified.

11. Examples

11.1 Stairs with landing

This example is saved in the project CAD_Object_Evaluation as Model Stair landing.d

New file. Select basement storey.

Create foundation slab with dimensions alongside

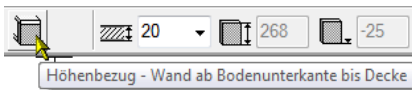
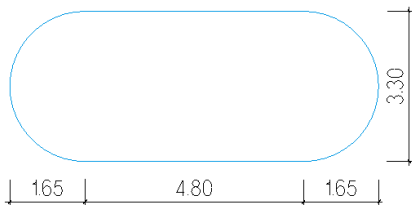

Create concrete wall, thickness 20 cm, with height reference bottom edge of floor to ceiling.

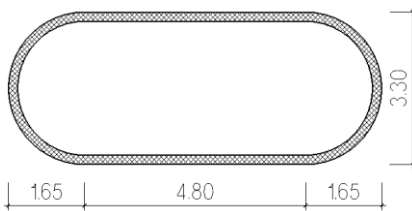

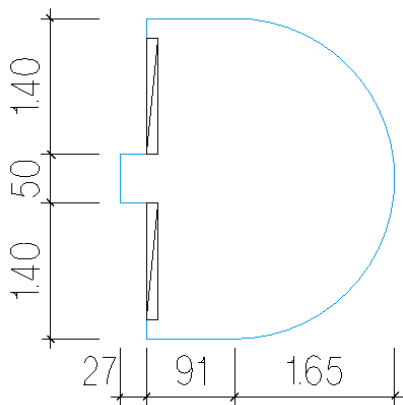
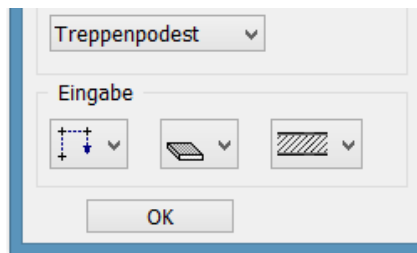
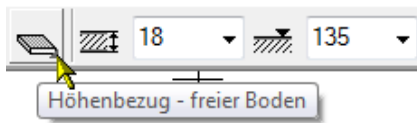

Intermediate landing with definition stair landing

Settings:

Height reference - free slab

Thickness 18 cm

Upper edge 135 cm

Concrete

Stair landing

Draw stair landing with dimensions alongside.

The stair landing should fully penetrate the wall.

In the illustration, the cut-outs for the stair supports are also drawn

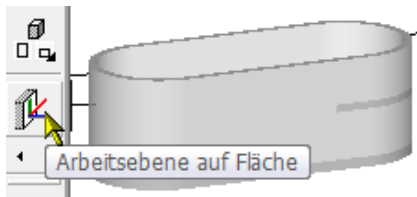

Cutting out the wall for the intermediate landing

This work stage can be dispensed with if no cut through the stair is created.

Click on the side of the wall with work plane set for surfaces, so that the working plane rotates.

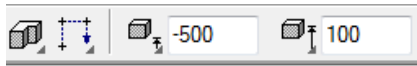

Create 3D box with bottom height -500 and top height 100.

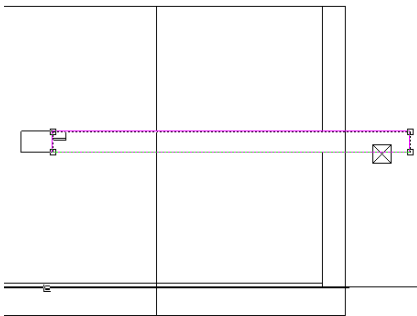
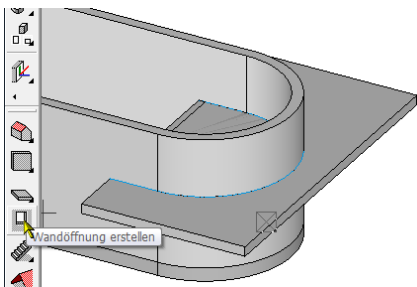
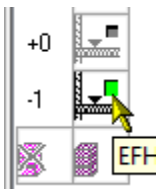

Illustration: side view of wall.

Draw a rectangle at the height of the intermediate landing. This should be drawn slightly farther to the right than the dimensions of the landing.



Using the function create wall opening, select 3D box as deduction volume.



Reset work plane using select storey.

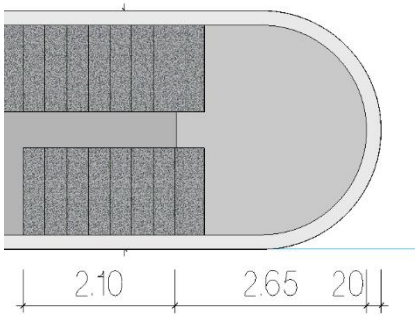

Lower stair run

Software interface for configuring a stair run. The interface includes a toolbar at the top with icons for selection, modification, and deletion. Below the toolbar, there are several sections for configuring the stair run:

- Stair Run Configuration:** A diagram shows a vertical stair run with a width of 120. The total width is 210, and the width of the landing is 250. The number of steps is 8.
- Stair Rise and Run:** The rise is 139, and the run is 0. The number of steps is 8.
- Stair Landing Configuration:** The width of the landing is 30, and the width of the stair run is 17.4. The calculation $2*I+J=64.8$ is shown in a red box.

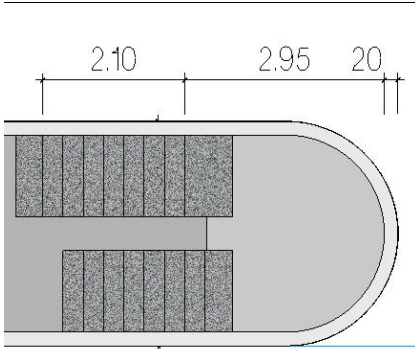

Upper stair run

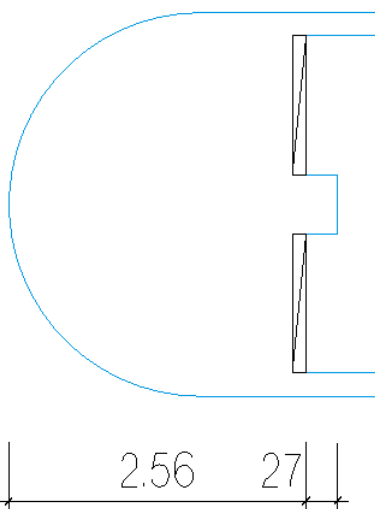

Draw the storey ceiling in Storey 0.

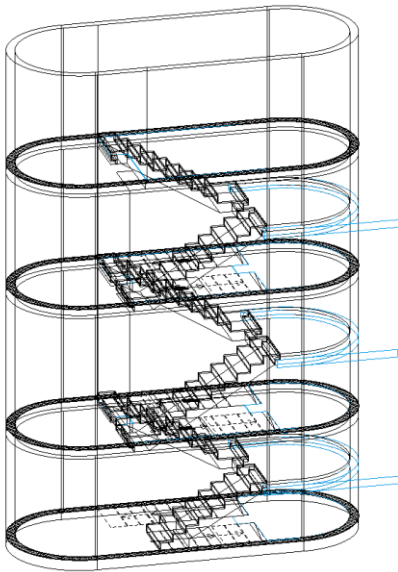

Repeat the process for all storeys or copy the construction parts to the upper storeys.

Room definition for stairs

Room definition in the lowest storey

In the lowest storey, a single room definition of the type “normal room” can be selected.

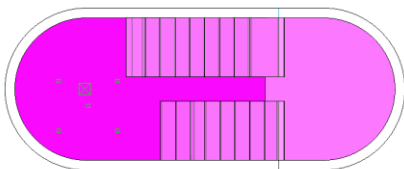

Flächentyp	<input type="text" value="a"/>
Flächenart	<input type="text" value="normaler Raum"/>

Room definition in the upper storeys

In the upper storeys, two room definitions are set, divided by a room separator on the storey floor edge at the transition to the stair runs.

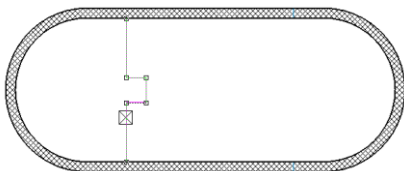

Room definition on storey floor

Above the storey floor, a normal room definition is set with the option “normal room”.

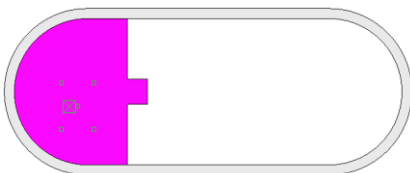

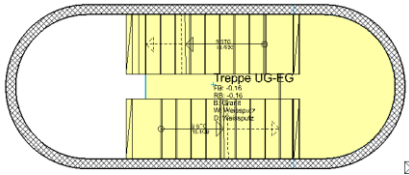

Flächentyp

Flächenart

Materialien

Boden	Granit	<input type="text" value="1"/>	<input type="text" value="0"/>
Wand	Weissputz	<input type="text" value="308"/>	<input type="text" value="2"/>
Decke	Weissputz	<input type="text" value="308"/>	<input type="text" value="2"/>

Room definition above the stair run

Standard SIA 416 allows for the area for the stairwell to be through-calculated for narrow stairwells. Accordingly, a room definition can be set above the runs of stairs (yellow area in the illustration).

Setting for room definition:

normal room

Floor finish on stairs, **Thickness 0**

Wall finish

Ceiling finish on the underside of the run of stairs located above, ceilings and roofs.

Room definition in the topmost storey

As in the previous section, one room definition is set above the storey floor and one above the stair run.

The approach satisfies the specification in the standards that the floor plan area for stairs always belongs to the storey above.

Room definition for large stairwells

If the stairwell is of such size that this area is no longer permitted to be calculated as net area according to the standards, then in the stairwell an additional room definition with type air space must be set.

Room finishes

Wall finish

Wall finishes on stairs close to walls are through-calculated.

Wall finish in the lowest storey

The wall finish is calculated to the underside of stairs (and their intermediate landings) and CAD slabs with definition stair landing.

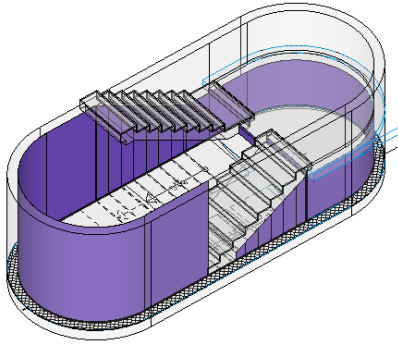

Wall finish in normal storeys

The wall finish is calculated between the stairs (and their intermediate landings) and CAD slabs with definition stair landing. In the illustration, in addition to the wall finish the room definition can be seen above the storey floor.

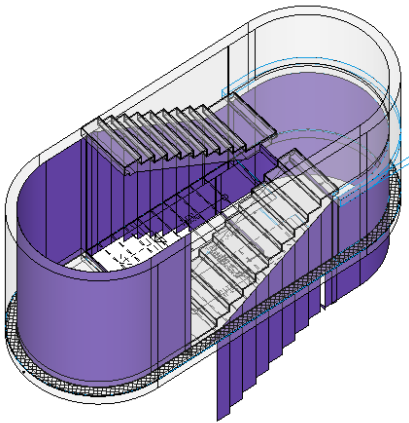

Wall finish in the topmost storey

The wall finish is calculated up to the stairs (and their intermediate landings) and CAD slabs with definition stair landing. In the illustration, in addition to the wall finish the room definition can be seen above the storey floor.

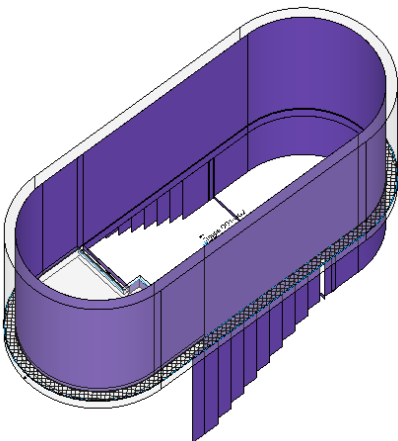

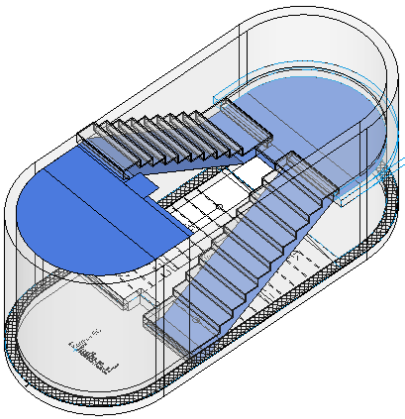

Slab finishes

Slab finishes

The slab finish is calculated on the underside of stairs (and their intermediate landings) and CAD slabs with definition stair landing. The calculated slab finish area corresponds to the measured area.

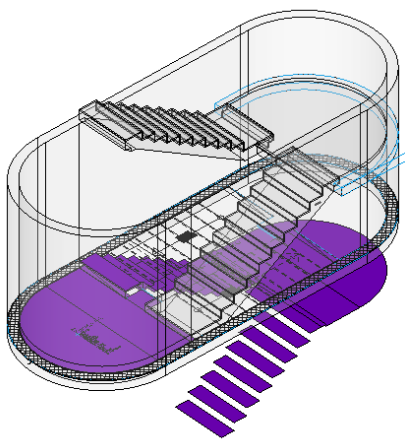

Floor finish

The floor finish is calculated to the next lower storey, as with all finishes. Measured area on stairs (and their intermediate landings) and CAD floors with definition stair landing.